

Drawing Number – W8
Outline Number – 101A212

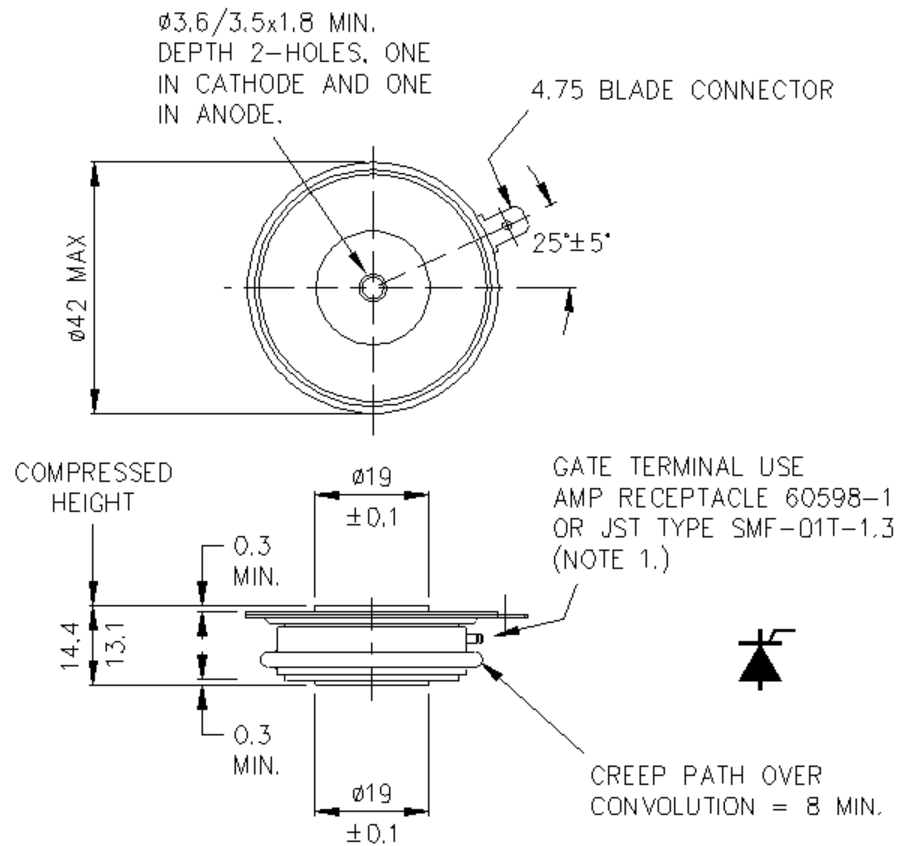

Weight 70g