

**Drawing Number – W62**  
**Outline Number – 101A314**

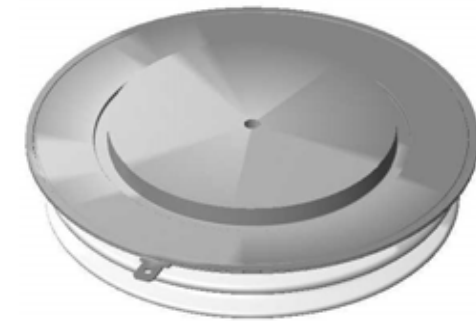
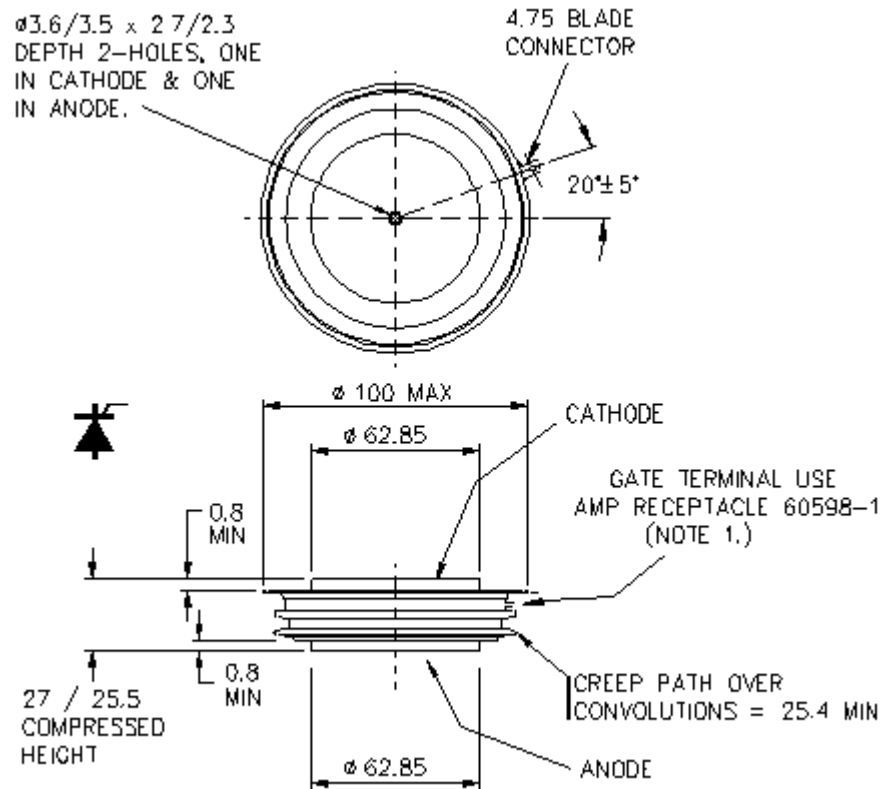

**Weight 1000g**