

Drawing Number – W59
Outline Number – 101A359

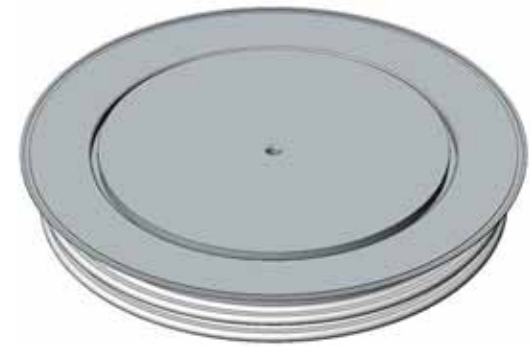
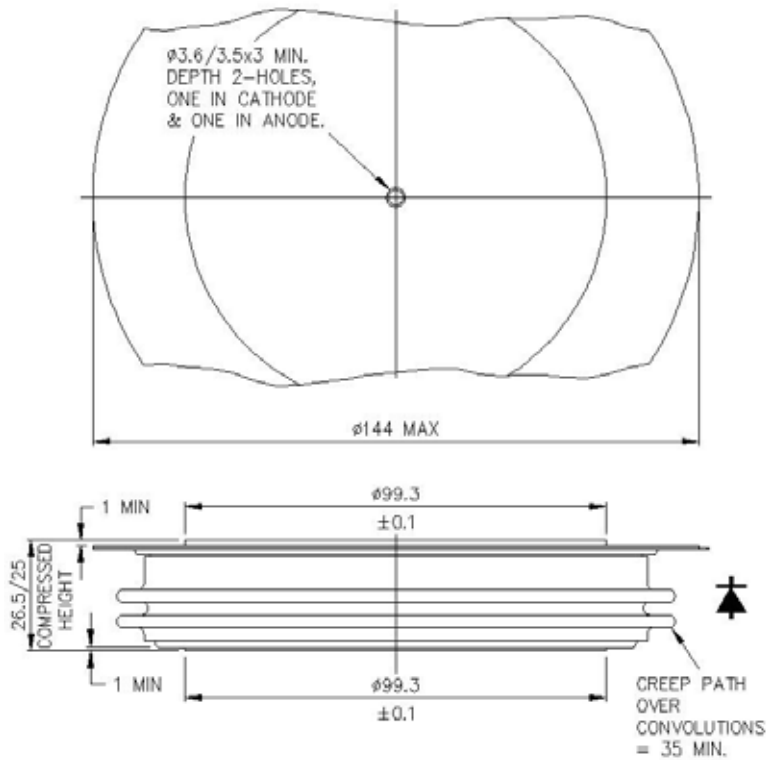

Weight 2000g