

Drawing Number – W57
Outline Number – 101A363

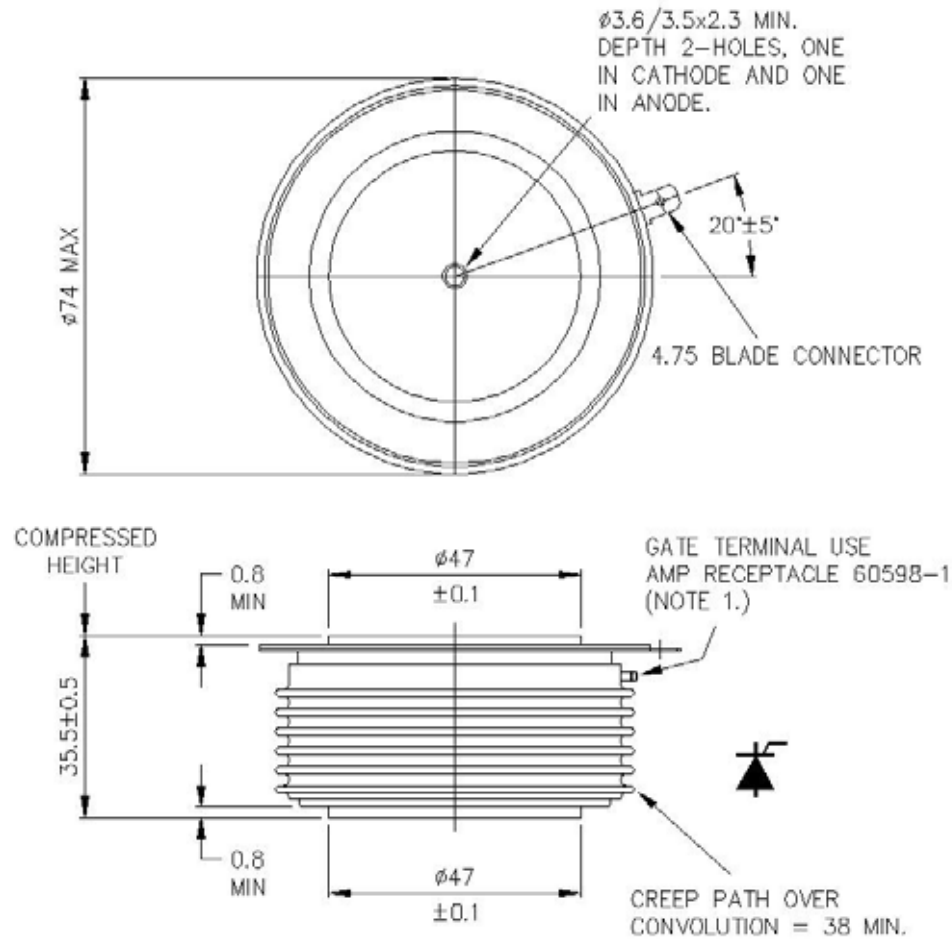

Weight 1230g