

Drawing Number – W56
Outline Number – 101A365

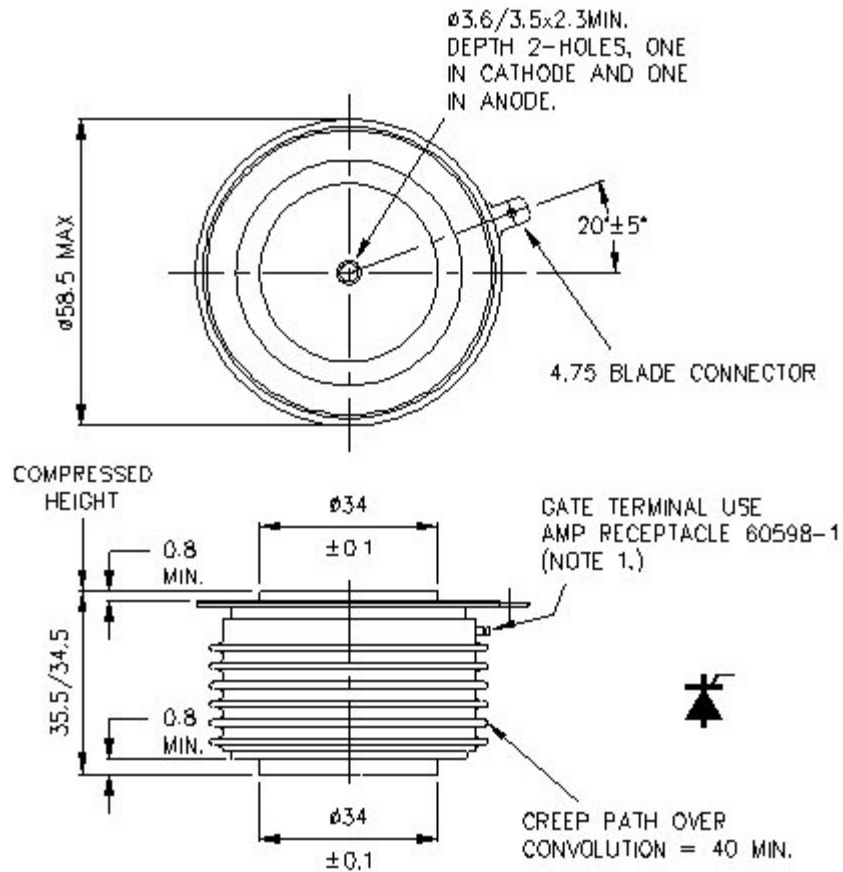

Weight 271g