

Drawing Number – W47
Outline Number – 100A322

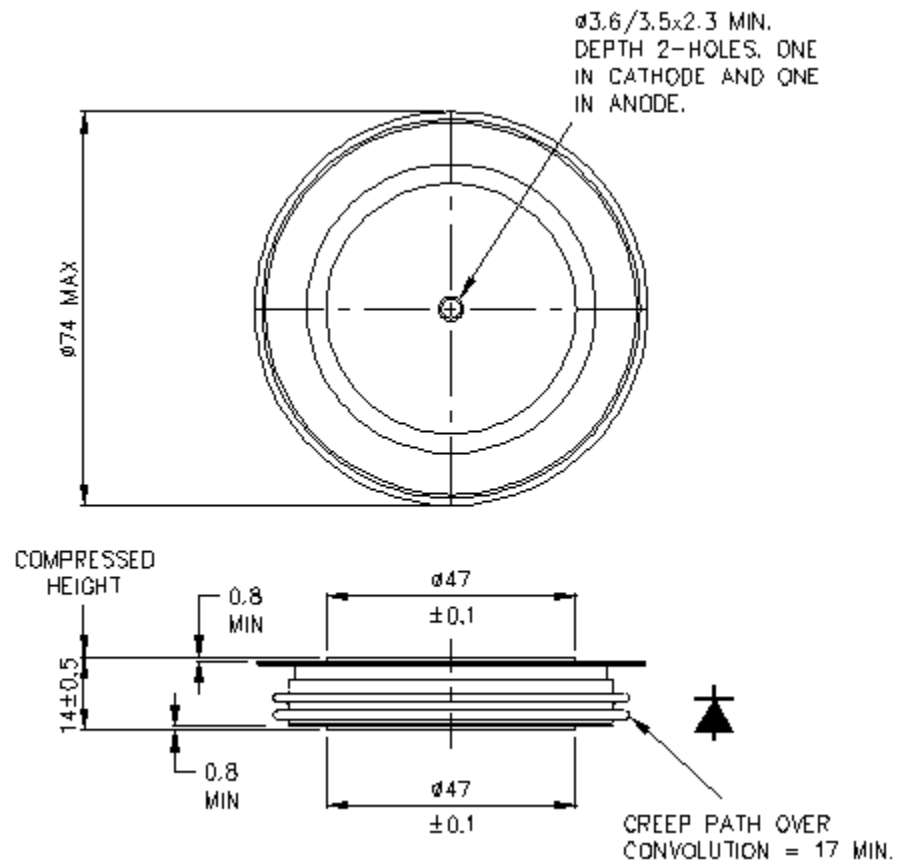

Weight 250g