

Drawing Number – W45
Outline Number – 101A359

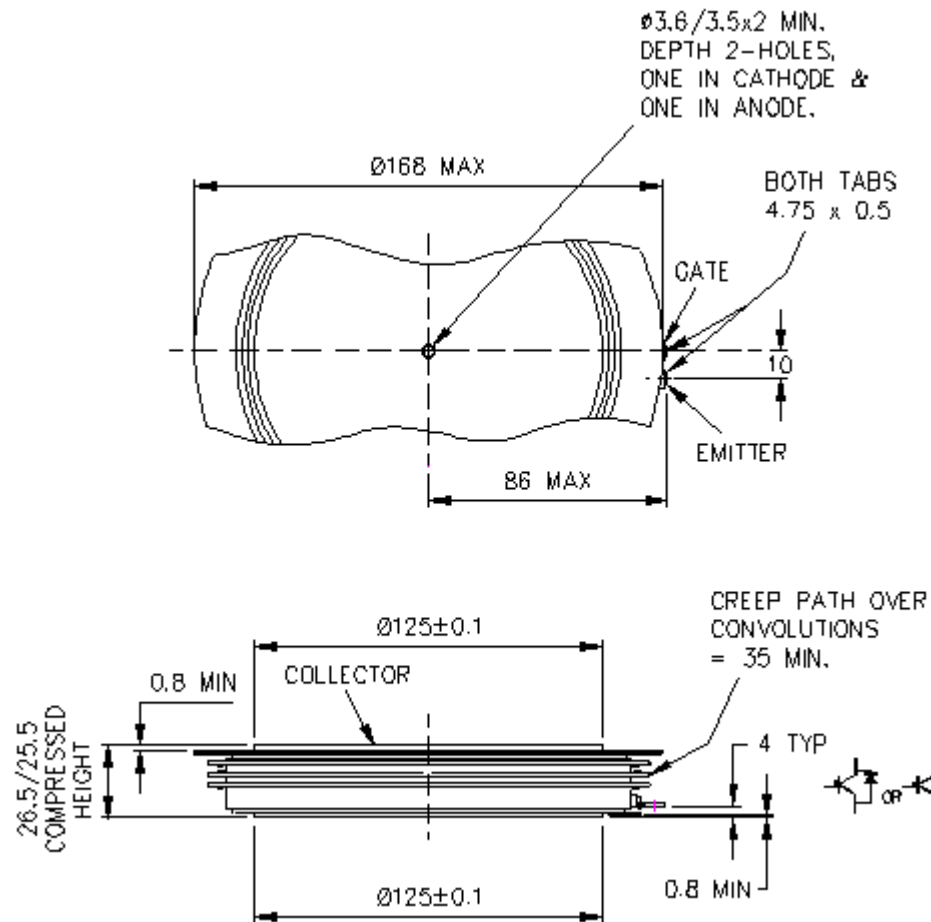

Weight 2000g