

Drawing Number – W41
Outline Number – 171A108

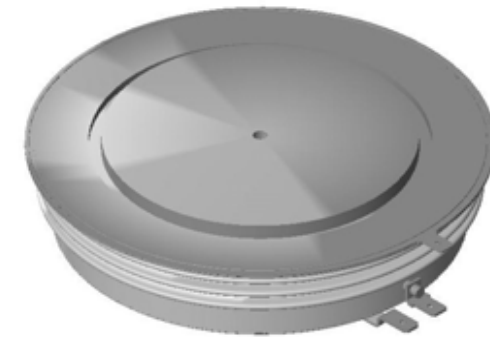
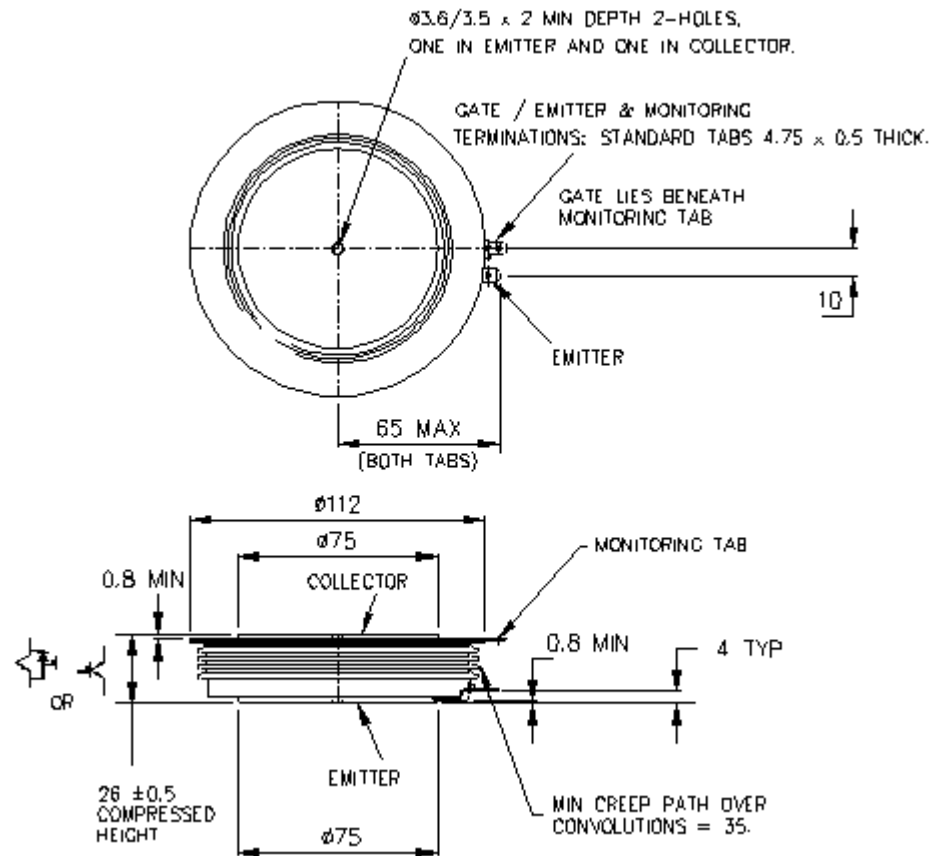

Weight 1200g