

**Drawing Number – W40**  
**Outline Number – 171A107**

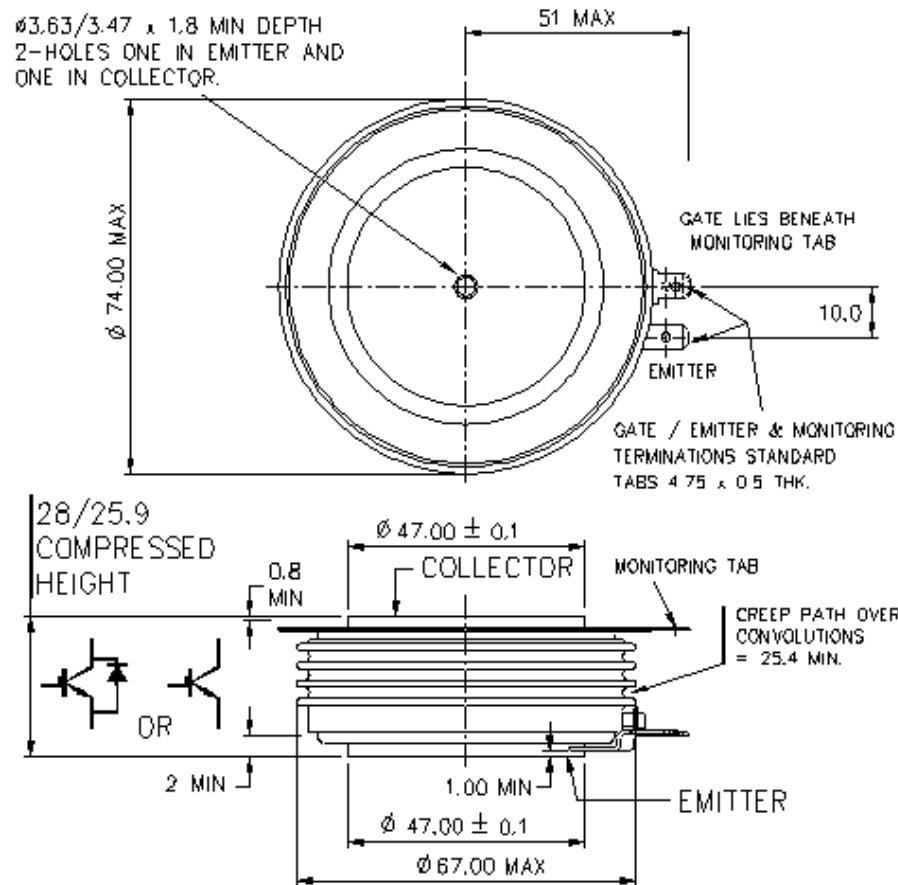

**Weight 500g**