

Drawing Number – W37  
Outline Number – 100A325

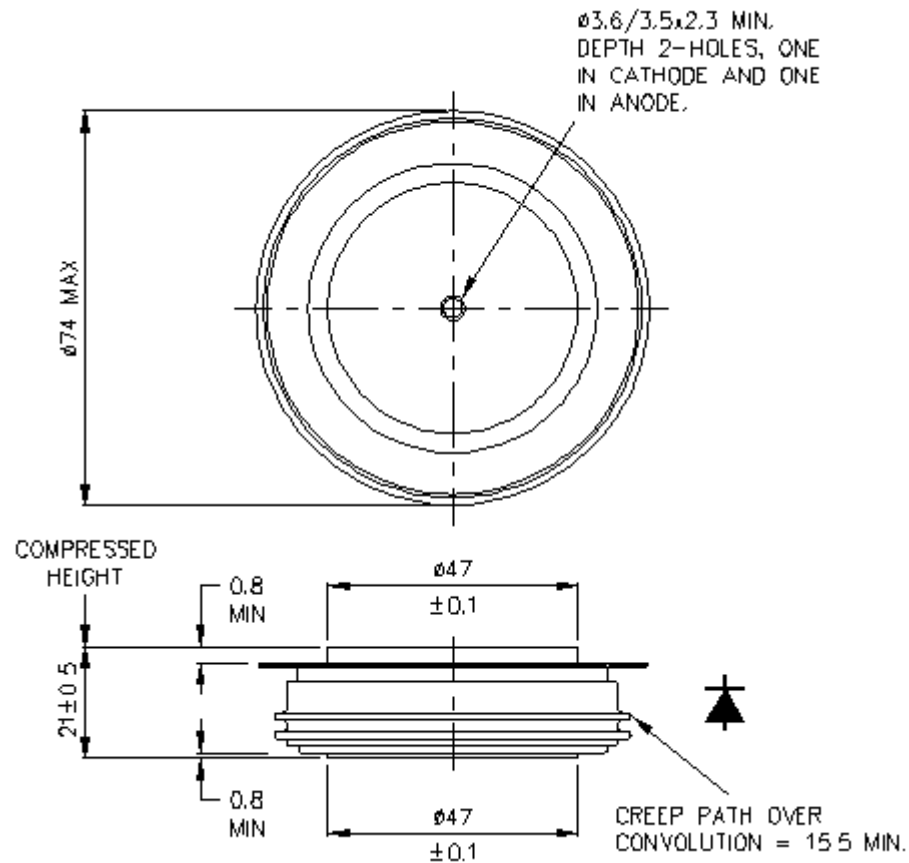

Weight 510g