

**Drawing Number – W36**  
**Outline Number – 101A288**

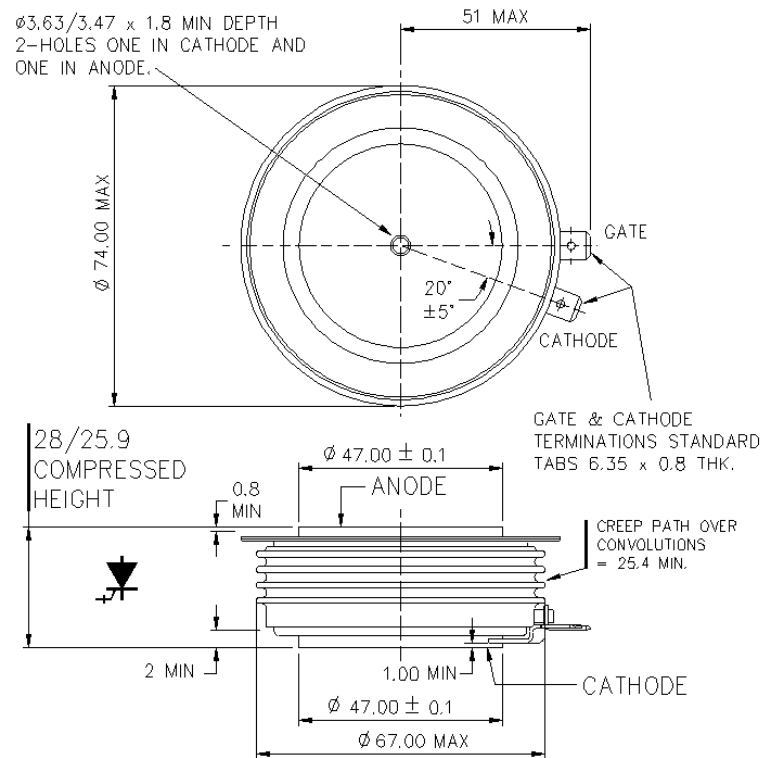

**Weight 500g**