

**Drawing Number – W35**  
**Outline Number – 101A358**

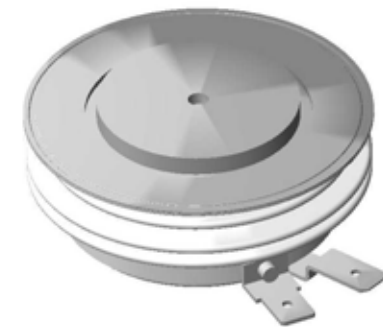
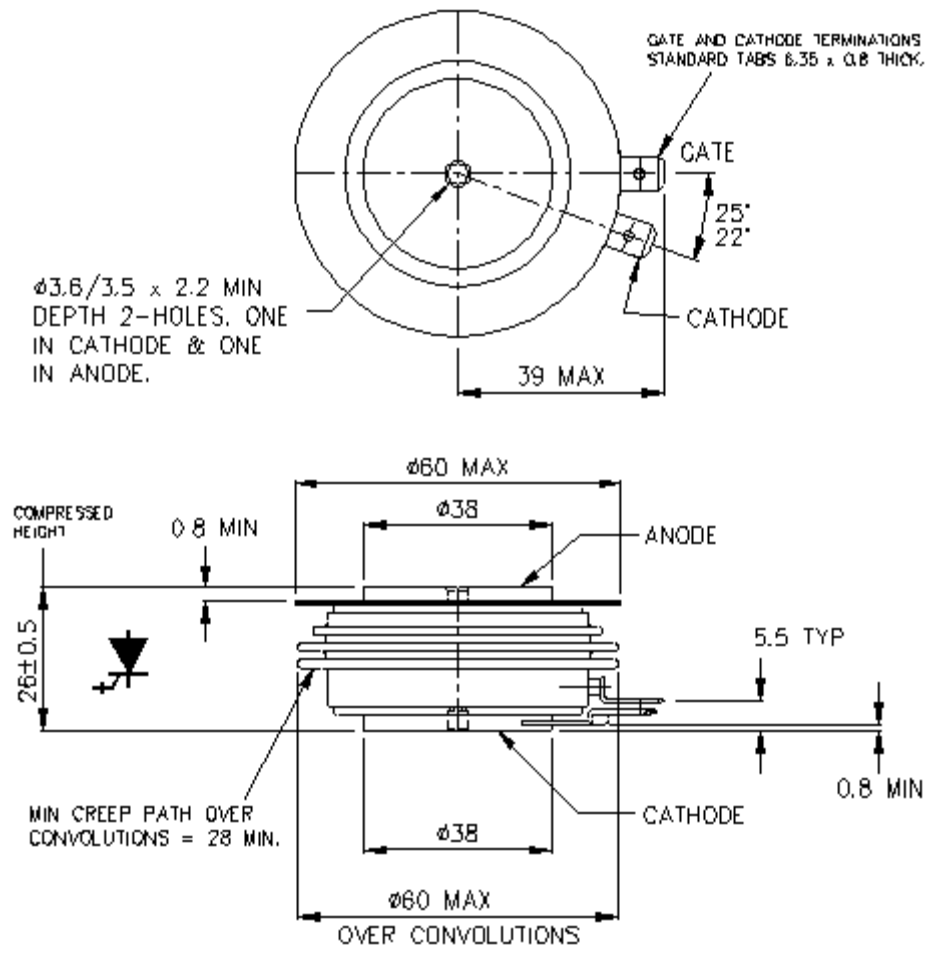

**Weight 300g**