

Drawing Number – W33
Outline Number – 101A346

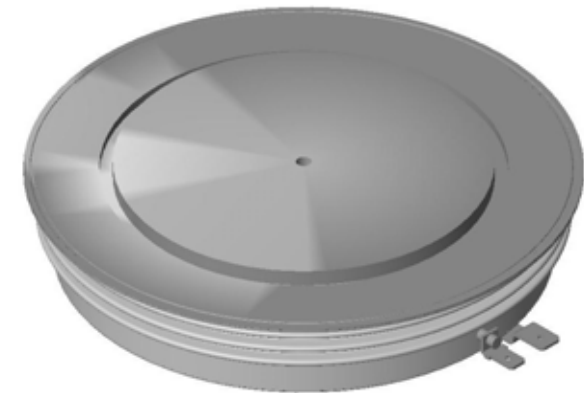
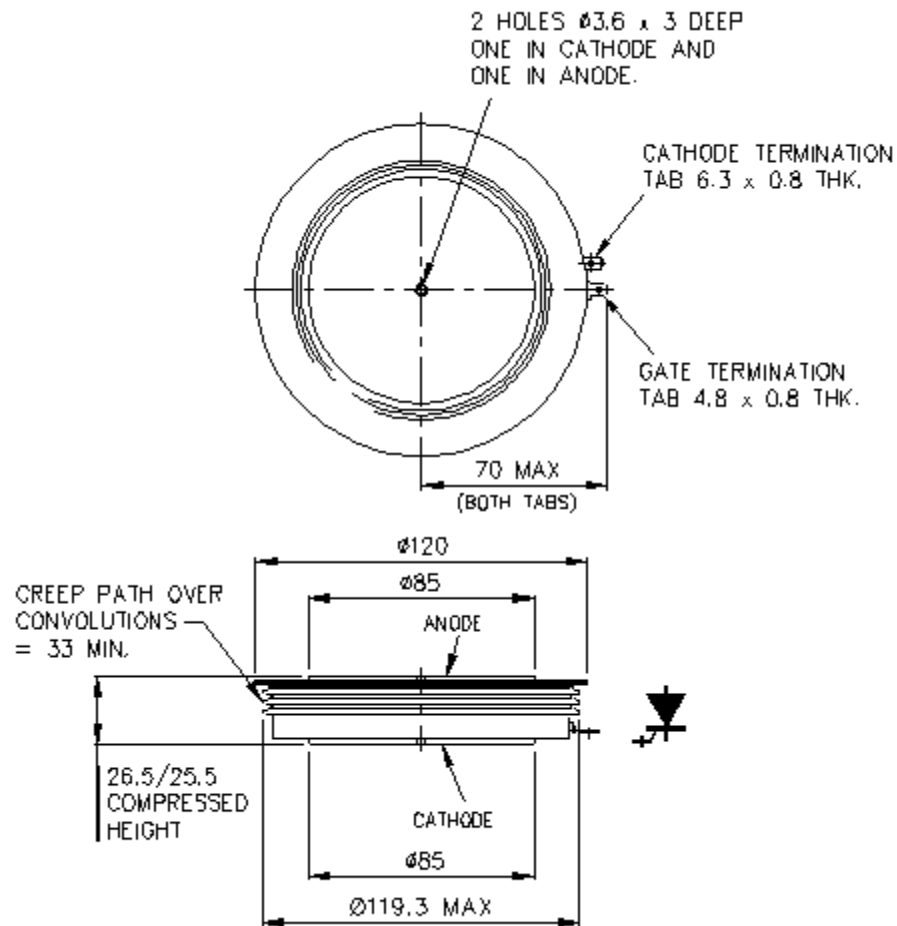

Weight 1500g