

Drawing Number – W31
Outline Number – 101A344

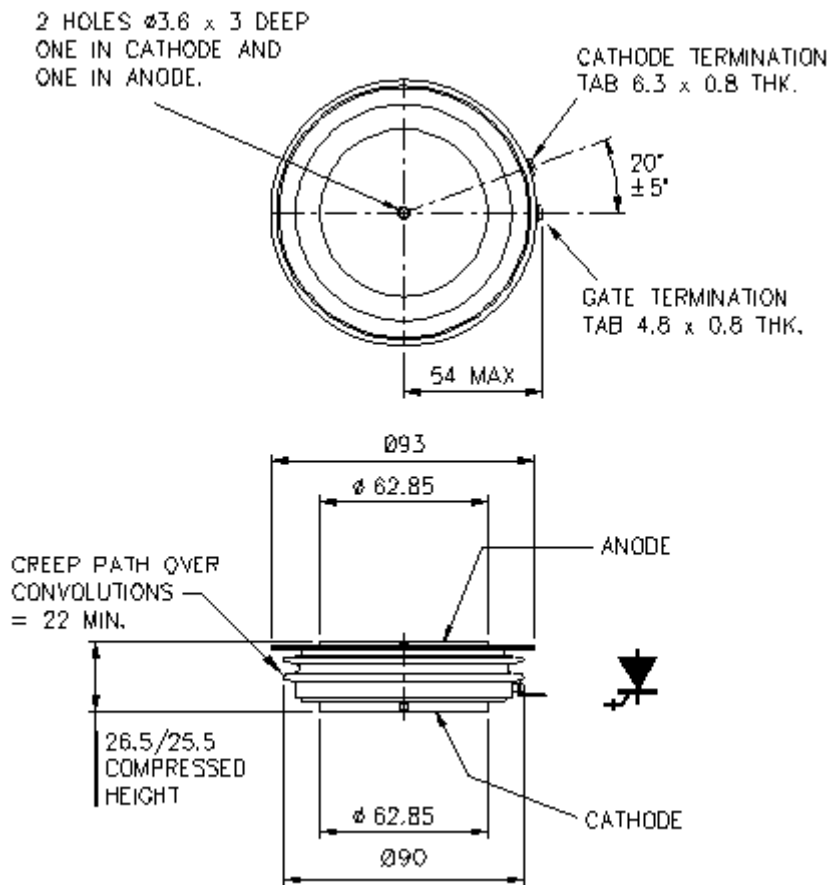

Weight 800g