

**Drawing Number – W30**  
**Outline Number – 101A343**

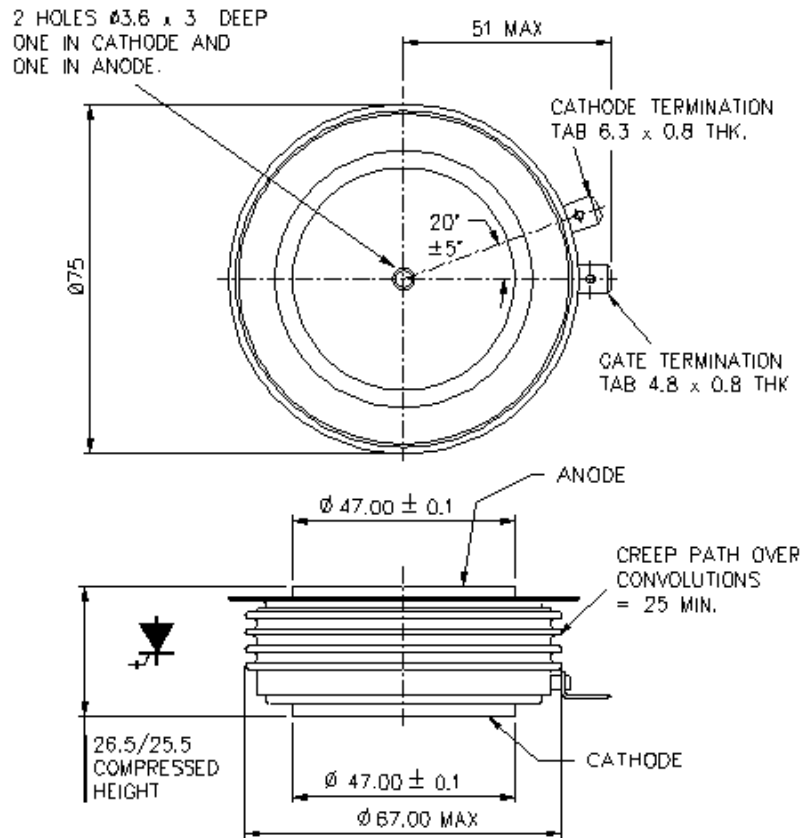

**Weight 600g**