

Drawing Number – W3
Outline Number – 100A317

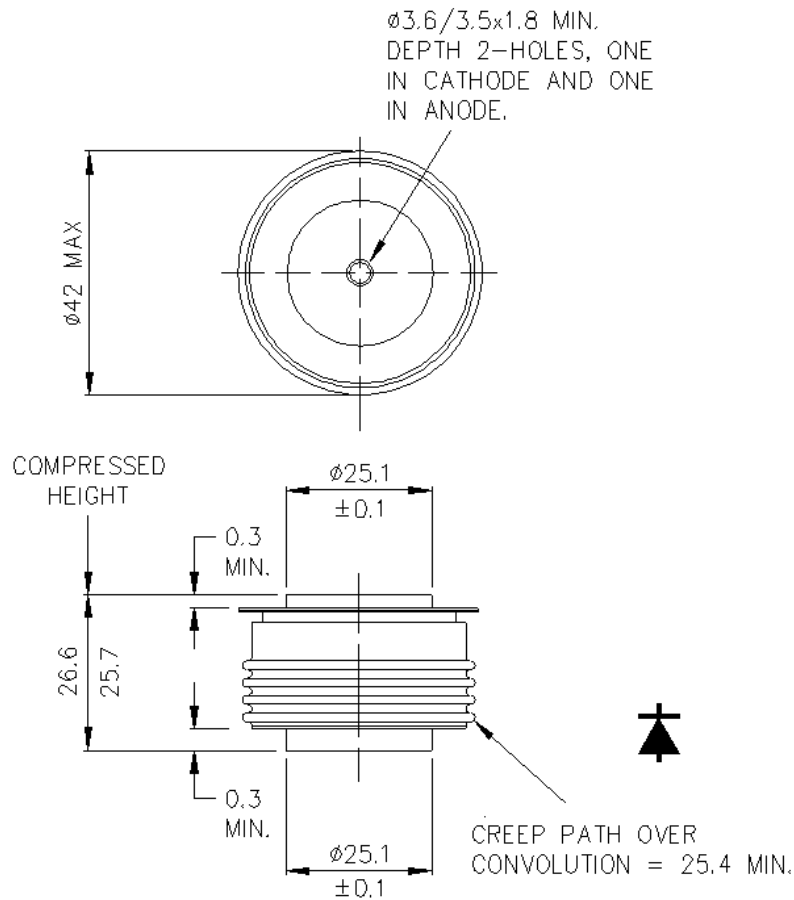

Weight 140g