

Drawing Number – W25  
Outline Number – 101A362

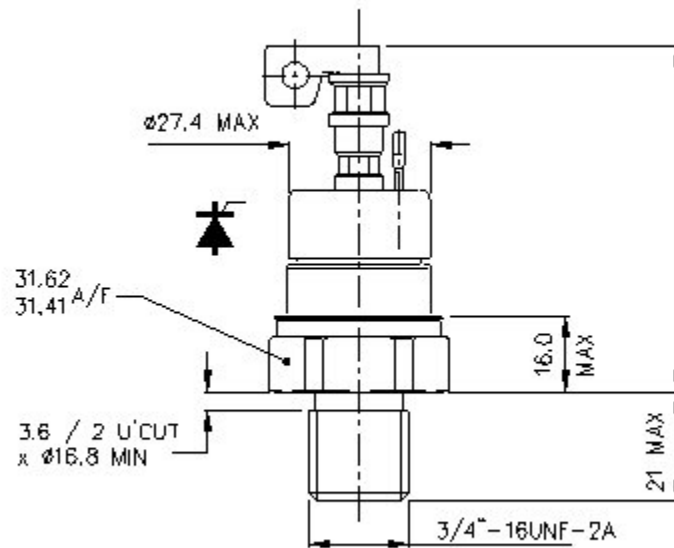

Weight 220g