

Drawing Number – W15
Outline Number – 101A322

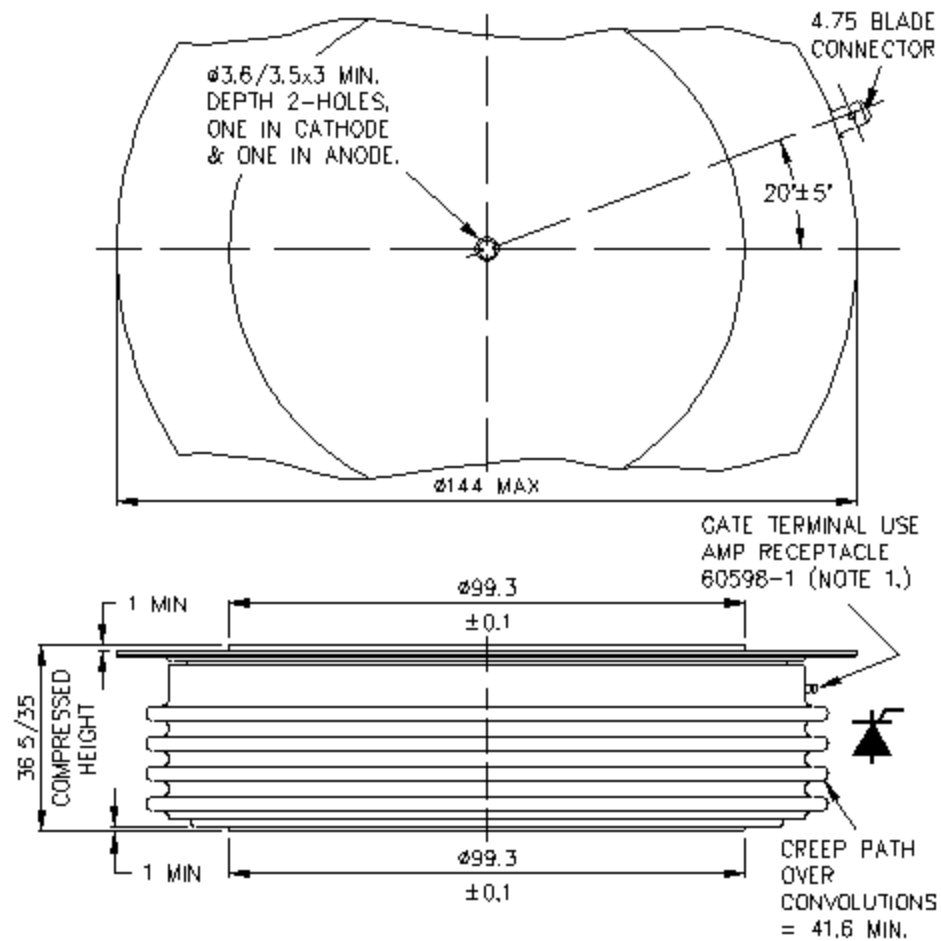

Weight 2800g