

**Drawing Number – W14**  
**Outline Number – 101A325**

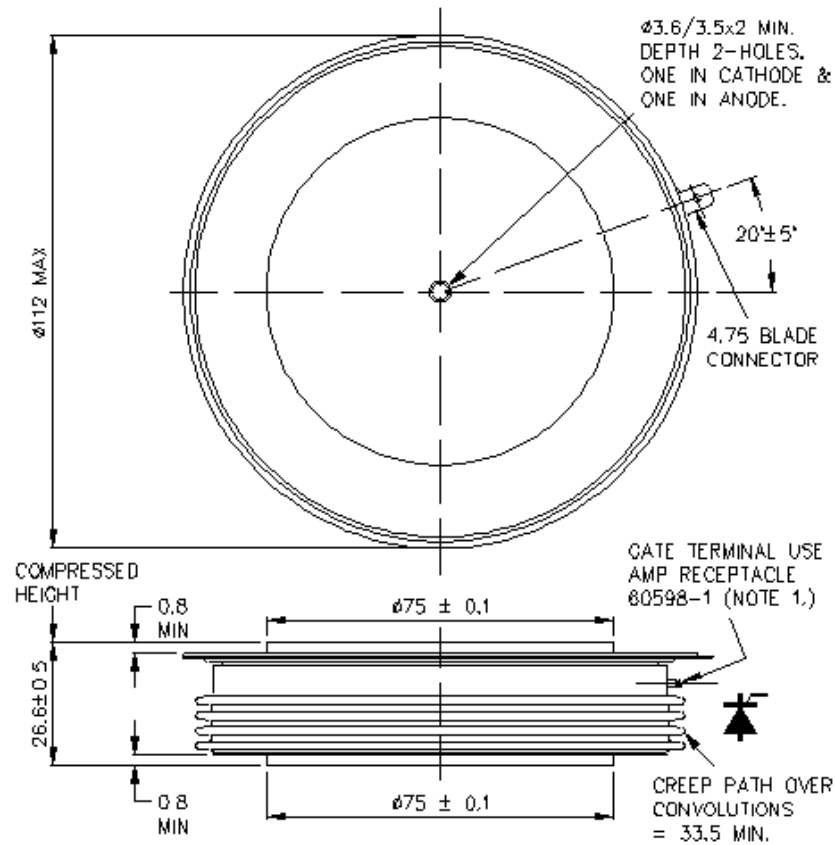

**Weight 1300g**