

Drawing Number – W13
Outline Number – 101A281

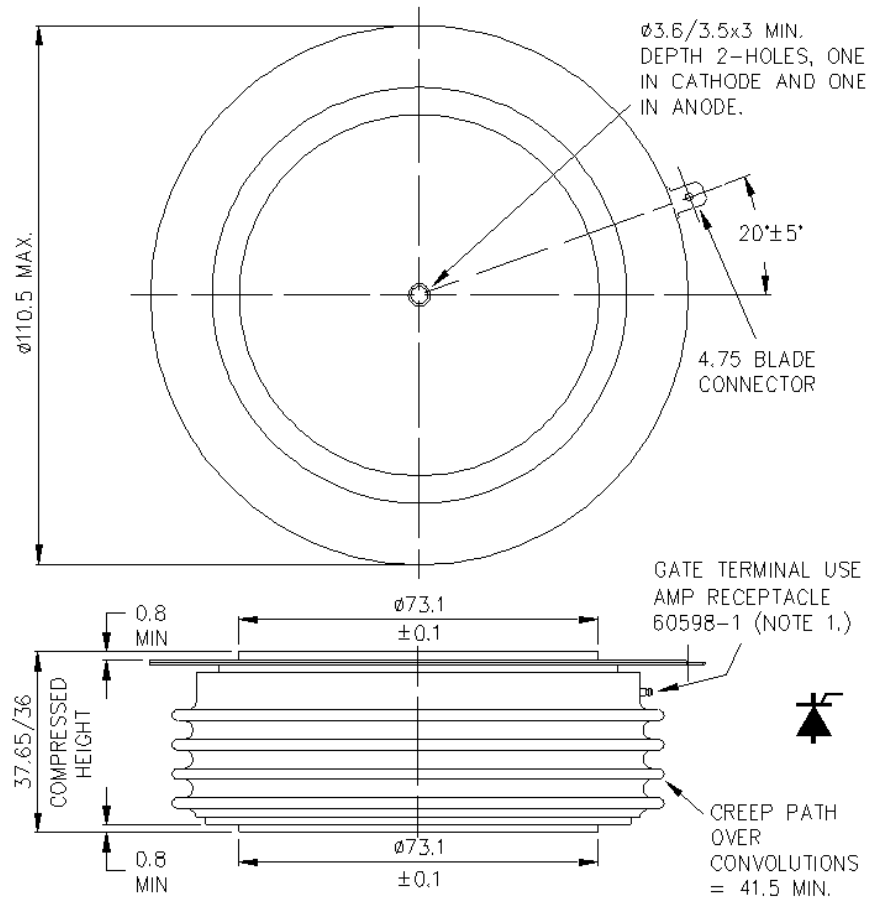

Weight 1700g