

**Drawing Number – W12**  
**Outline Number – 101A232**

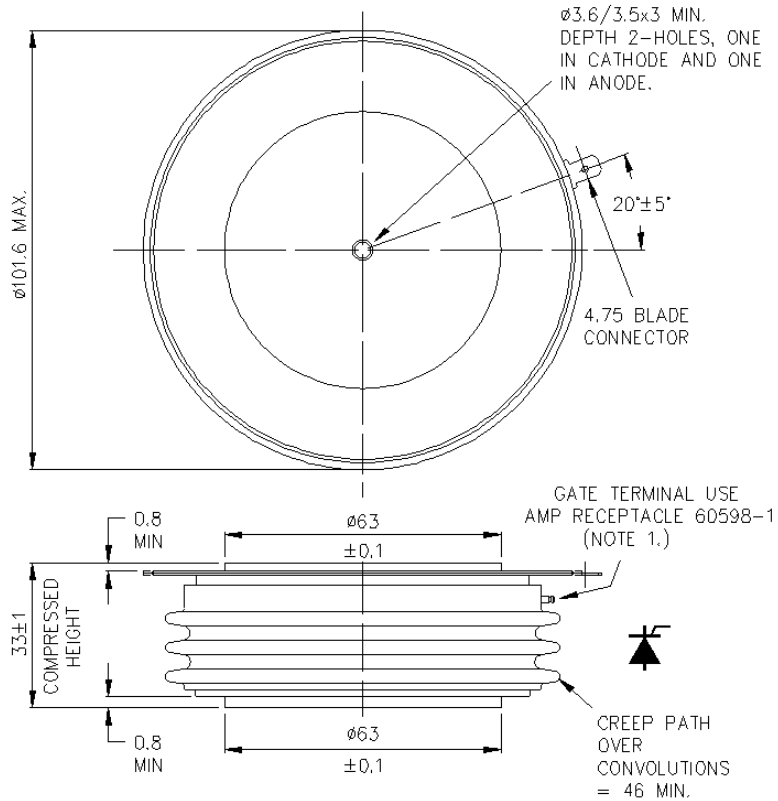

**Weight 1000g**