

**Drawing Number – W11**  
**Outline Number – 101A223**

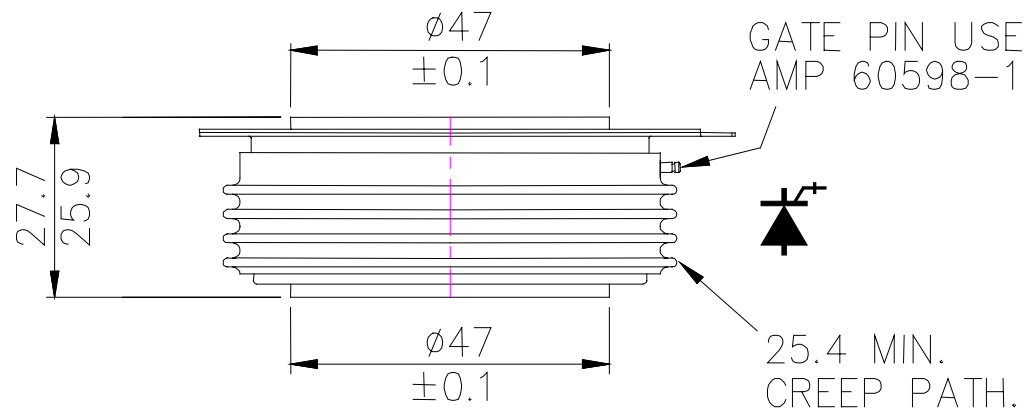
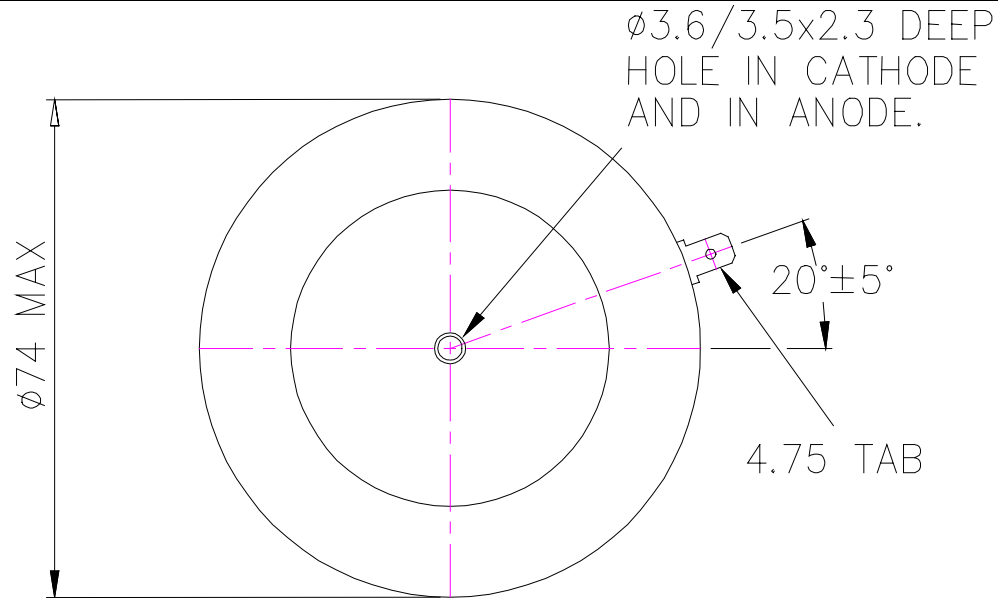

**WESTCODE**

An  IXYS Company

[www.westcode.com](http://www.westcode.com)

[www.ixys.com](http://www.ixys.com)

**IXYS Semiconductor GmbH**

Edisonstraße 15  
D-68623 Lampertheim  
Tel: +49 6206 503-0  
Fax: +49 6206 503-627  
E-mail: [marcom@ixys.de](mailto:marcom@ixys.de)

**IXYS Corporation**

3540 Bassett Street  
Santa Clara CA 95054 USA  
Tel: +1 (408) 982 0700  
Fax: +1 (408) 496 0670  
E-mail: [sales@ixys.net](mailto:sales@ixys.net)

**Westcode Semiconductors Ltd**

Langley Park Way, Langley Park,  
Chippenham, Wiltshire, SN15 1GE.  
Tel: +44 (0)1249 444524  
Fax: +44 (0)1249 659448  
E-mail: [WSL.sales@westcode.com](mailto:WSL.sales@westcode.com)

**Westcode Semiconductors Inc**

3270 Cherry Avenue  
Long Beach CA 90807 USA  
Tel: +1 (562) 595 6971  
Fax: +1 (562) 595 8182  
E-mail: [WSI.sales@westcode.com](mailto:WSI.sales@westcode.com)