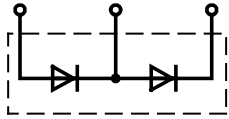
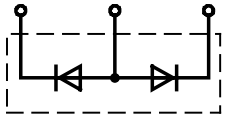
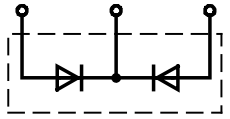

Dual Diode Water Cooled Modules MD# 950

Absolute Maximum Ratings

| V_{RRM} V_{DRM} [V] |  MDD |  MDA |  MDK |
|-------------------------------|--|---|--|
| 1200 | 950-12N1W | 950-12N1W | 950-12N1W |
| 1400 | 950-14N1W | 950-14N1W | 950-14N1W |
| 1600 | 950-16N1W | 950-16N1W | 950-16N1W |
| 1800 | 950-18N1W | 950-18N1W | 950-18N1W |
| 2000 | 950-20N1W | 950-20N1W | 950-20N1W |
| 2200 | 950-22N1W | 950-22N1W | 950-22N1W |

| | VOLTAGE RATINGS | MAXIMUM LIMITS | UNITS |
|-----------|---|----------------|-------|
| V_{RRM} | Repetitive peak reverse voltage ¹⁾ | 1200-2200 | V |
| V_{RSM} | Non-repetitive peak reverse voltage ¹⁾ | 1300-2300 | V |

| | OTHER RATINGS | MAXIMUM LIMITS | UNITS |
|---------------|---|--------------------|------------------|
| $I_{F(AV)M}$ | Maximum average forward current. $T_{water} = 17^{\circ}C$, 4l/min ^{2), 3)} | 1129 | A |
| $I_{F(AV)M}$ | Maximum average forward current. $T_{water} = 45^{\circ}C$, 4l/min ^{2), 3)} | 950 | A |
| $I_{F(AV)M}$ | Maximum average forward current. $T_{water} = 85^{\circ}C$, 4l/min ^{2), 3)} | 668 | A |
| $I_{F(RMS)}$ | Nominal RMS forward current. $T_{water} = 17^{\circ}C$, 4l/min ^{2), 3)} | 1773 | A |
| $I_{F(d.c.)}$ | D.C. forward current. $T_{water} = 17^{\circ}C$, 4l/min ³⁾ | 1427 | A |
| I_{TSM} | Peak non-repetitive surge $t_p = 10$ ms, $V_{RM} = 60\%V_{RRM}$ ⁴⁾ | 21.8 | kA |
| I_{TSM2} | Peak non-repetitive surge $t_p = 10$ ms, $V_{RM} \leq 10$ V ⁴⁾ | 24.0 | kA |
| I^2t | I^2t capacity for fusing $t_p = 10$ ms, $V_{RM} = 60\%V_{RRM}$ ⁴⁾ | 2.38×10^6 | A ² s |
| I^2t | I^2t capacity for fusing $t_p = 10$ ms, $V_{RM} \leq 10$ V ⁴⁾ | 2.88×10^6 | A ² s |
| V_{isol} | Isolation Voltage ⁵⁾ | 3500 | V |
| $T_{j op}$ | Operating temperature range | -40 to +125 | °C |
| $T_{j max}$ | Maximum junction temperature | +150 | °C |
| T_{stg} | Storage temperature range | -40 to +125 | °C |

Notes:

- 1) De-rating factor of 0.13% per °C is applicable for T_{vj} below 25°C.
- 2) Single phase; 50 Hz, 180° half-sinewave.
- 3) Current ratings do not include adjustments, which may be necessary due to heat being returned by cable connections.
- 4) Half-sinewave, 150°C T_{vj} initial.
- 5) AC RMS voltage, 50 Hz, 1min test.

Characteristics

| | PARAMETER | MIN. | TYP. | MAX. | TEST CONDITIONS ¹⁾ | UNITS |
|-------------------|---------------------------------------|------|------|------|--|-------|
| V _{FM} | Maximum peak forward voltage | - | - | 1.35 | I _{FM} = 2850 A | V |
| V _{FM} | Maximum peak forward voltage | - | - | 0.88 | I _{FM} = 500 A | V |
| V _{T0} | Threshold voltage | - | - | 0.75 | | V |
| r _T | Slope resistance | - | - | 0.2 | | mΩ |
| I _{RRM} | Peak reverse current | - | - | 50 | Rated V _{RRM} | mA |
| Q _{rr} | Recovered Charge | - | 1800 | - | | μC |
| Q _{ra} | Recovered Charge, 50% chord | - | 1500 | 1750 | I _{FM} = 1000 A, t _p = 1 ms, di/dt = 10 A/μs, V _r = 50 V | μC |
| I _{rm} | Reverse recovery current | - | 165 | - | | A |
| t _{rr} | Reverse recovery time, 50% chord | - | 18 | - | | μs |
| R _{thJW} | Thermal resistance, junction to water | - | - | 0.09 | Single Diode | K/W |
| F ₁ | Mounting force (to heatsink) | 4.25 | - | 5.75 | | Nm |
| F ₂ | Mounting force (to terminals) | 10.2 | - | 13.8 | ²⁾ | Nm |
| W _t | Weight | - | 1.2 | - | | kg |

Notes:1) Unless otherwise indicated T_{vj} = 150°C

2) Screws must be lubricated

Notes on Ratings and Characteristics

1.0 Voltage Grade Table

| Voltage Grade | V _{RRM} V | V _{RSM} V | V _R DC V |
|---------------|-----------------------|-----------------------|------------------------|
| 12 | 1200 | 1300 | 820 |
| 14 | 1400 | 1500 | 930 |
| 16 | 1600 | 1700 | 1040 |
| 18 | 1800 | 1900 | 1150 |
| 20 | 2000 | 2100 | 1260 |
| 22 | 2200 | 2300 | 1370 |

2.0 Extension of Voltage Grades

This report is applicable to other voltage grades when supply has been agreed by Sales/Production.

3.0 De-rating Factor

A blocking voltage de-rating factor of 0.13%/°C is applicable to this device for T_j below 25°C.

4.0 Snubber Components

When selecting snubber components, care must be taken not to use excessively large values of snubber capacitor or excessively small values of snubber resistor. Such excessive component values may lead to device damage due to the large resultant values of snubber discharge current. If required, please consult the factory for assistance.

5.0 Computer Modelling Parameters

5.1 Device Dissipation Calculations

$$I_{AV} = \frac{-V_{T0} + \sqrt{V_{T0}^2 + 4 \cdot ff^2 \cdot r_T \cdot W_{AV}}}{2 \cdot ff^2 \cdot r_T} \quad \text{and:} \quad W_{AV} = \frac{\Delta T}{R_{th}}$$

$$\Delta T = T_{j\max} - T_K$$

Where V_{T0}=0.75V, r_T=0.2mΩ,

R_{th} = Supplementary thermal impedance, see table below and

ff = Form factor, see table below.

| Supplementary Thermal Impedance | | | | | | | |
|---------------------------------|--------|--------|--------|--------|--------|--------|-------|
| Conduction Angle | 30° | 60° | 90° | 120° | 180° | 270° | d.c. |
| Square wave | 0.0976 | 0.0955 | 0.0942 | 0.0933 | 0.0920 | 0.0907 | 0.090 |
| Sine wave | 0.0950 | 0.0933 | 0.0924 | 0.0917 | 0.0902 | | |

| Form Factors | | | | | | | |
|------------------|-------|-------|------|-------|-------|-------|------|
| Conduction Angle | 30° | 60° | 90° | 120° | 180° | 270° | d.c. |
| Square wave | 3.464 | 2.449 | 2 | 1.732 | 1.414 | 1.149 | 1 |
| Sine wave | 3.98 | 2.778 | 2.22 | 1.879 | 1.57 | | |

5.2 Calculating V_F using ABCD Coefficients

The on-state characteristic I_F vs. V_F , on page 6 is represented in two ways;

- (i) the well established V_{T0} and r_T tangent used for rating purposes and
- (ii) a set of constants A, B, C, D, forming the coefficients of the representative equation for V_F in terms of I_F given below:

$$V_F = A + B \cdot \ln(I_F) + C \cdot I_F + D \cdot \sqrt{I_F}$$

The constants, derived by curve fitting software, are given below for both hot and cold characteristics. The resulting values for V_F agree with the true device characteristic over a current range, which is limited to that plotted.

| 25°C Coefficients | | 150°C Coefficients | |
|-------------------|---------------------------|--------------------|----------------------------|
| A | 0.46164273 | A | 0.435837127 |
| B | 0.1048225 | B | 0.06435749 |
| C | 1.6116×10^{-4} | C | 1.84243×10^{-4} |
| D | -7.48063×10^{-3} | D | -2.353947×10^{-3} |

5.3 D.C. Thermal Impedance Calculation

$$r_t = \sum_{p=1}^{p=n} r_p \cdot \left(1 - e^{-\frac{t}{\tau_p}} \right)$$

Where $p = 1$ to n , n is the number of terms in the series and:

t = Duration of heating pulse in seconds.

r_t = Thermal resistance at time t .

r_p = Amplitude of p_{th} term.

τ_p = Time Constant of r_{th} term.

The coefficients for this device are shown in the tables below:

| D.C. | | | | | |
|----------|---------|--------------------------|--------------------------|--------------------------|--------------------------|
| Term | 1 | 2 | 3 | 4 | 5 |
| r_p | 0.07972 | 3.64310×10^{-3} | 4.87795×10^{-3} | 1.91134×10^{-3} | 2.16406×10^{-3} |
| τ_p | 4.46119 | 0.71394 | 0.06312 | 5.07740×10^{-3} | 6.07258×10^{-3} |

6.0 Reverse recovery ratings

(i) Q_{ra} is based on 50% I_{RM} chord as shown in Fig. 1

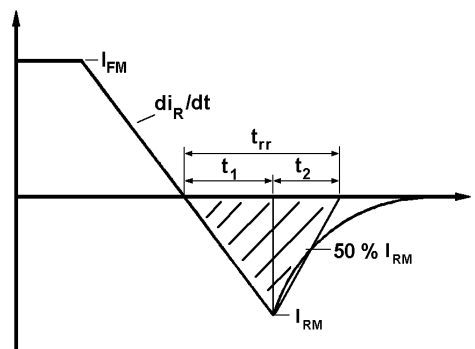

Fig. 1

(ii) Q_{rr} is based on a 150 μs integration time i.e.

$$Q_{rr} = \int_0^{150 \mu s} i_{rr} \cdot dt$$

(iii)

$$K \text{ Factor} = \frac{t_1}{t_2}$$

Curves

Figure 1 - Forward characteristics of Limit device

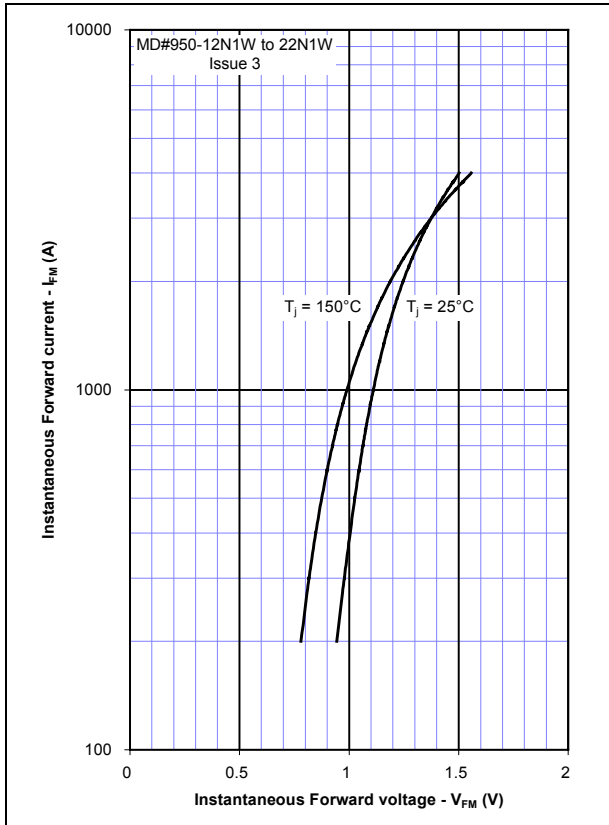

Figure 2 - Transient thermal impedance

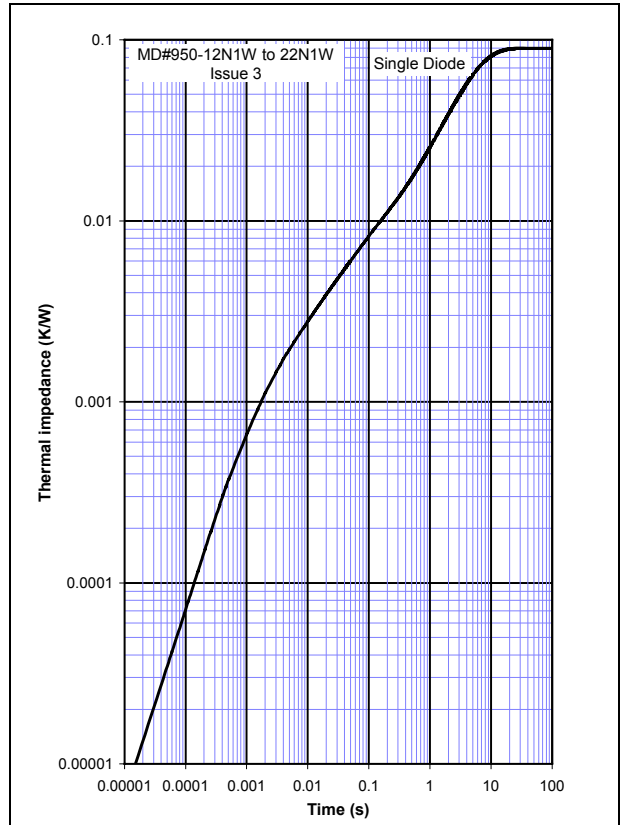

Figure 3 - Average forward current and Power loss Vs. Inlet water temperature

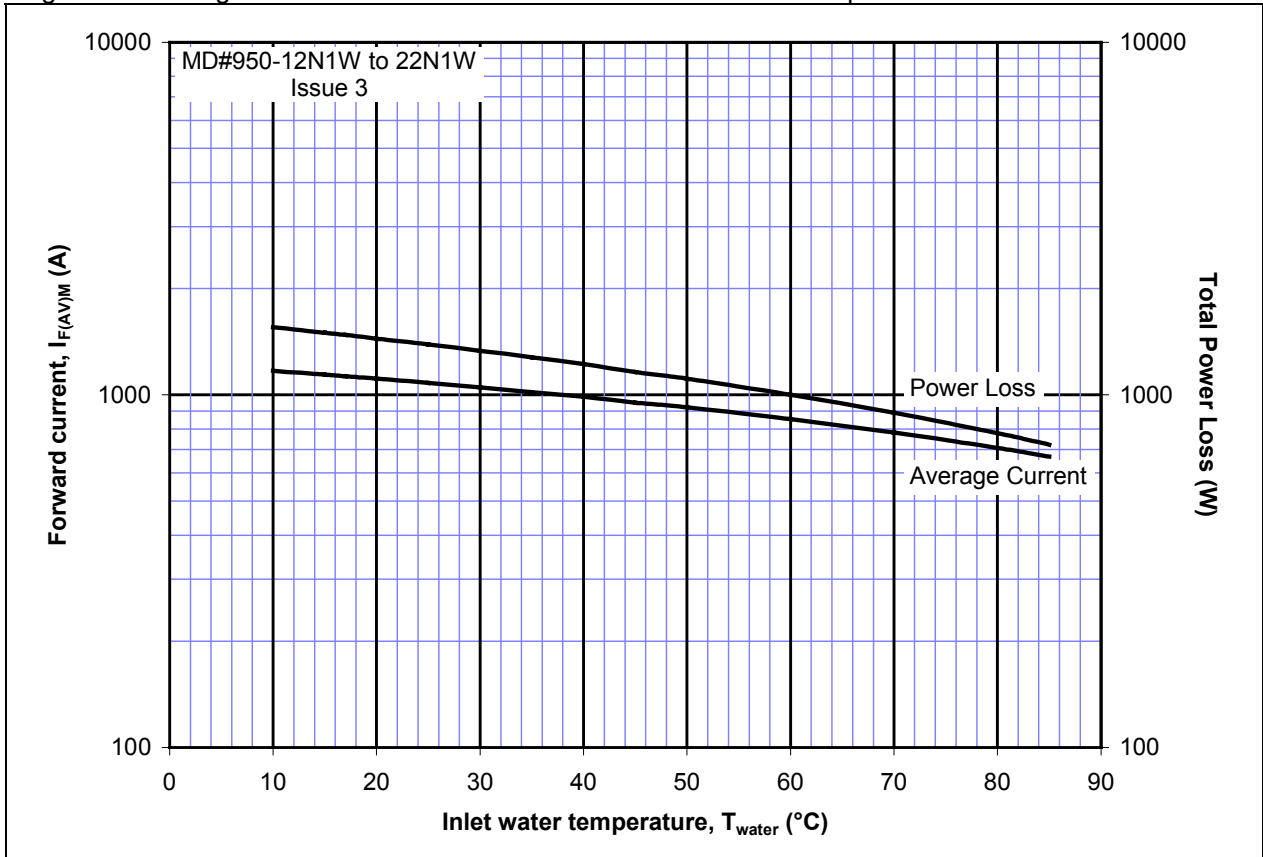

Figure 4 - Total recovered charge, Q_{rr}

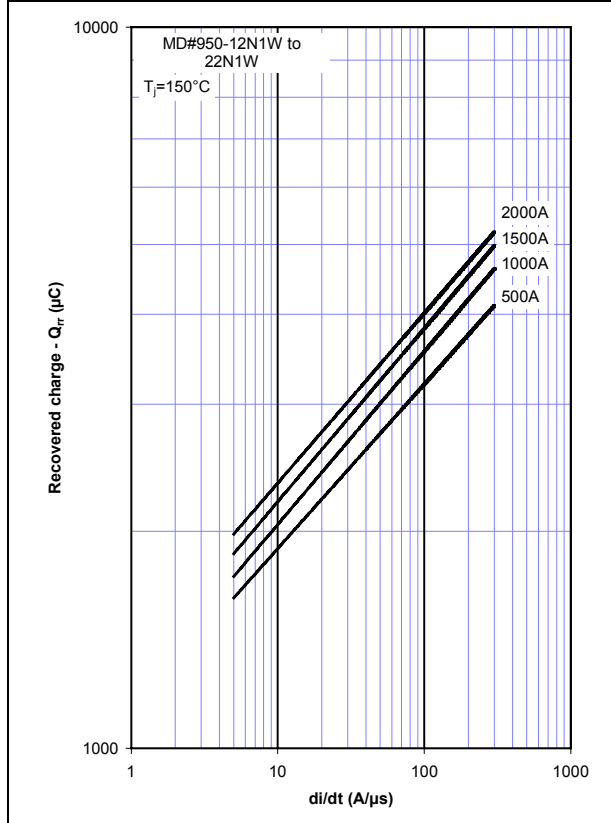

Figure 5 - Recovered charge, Q_{ra} (50% chord)

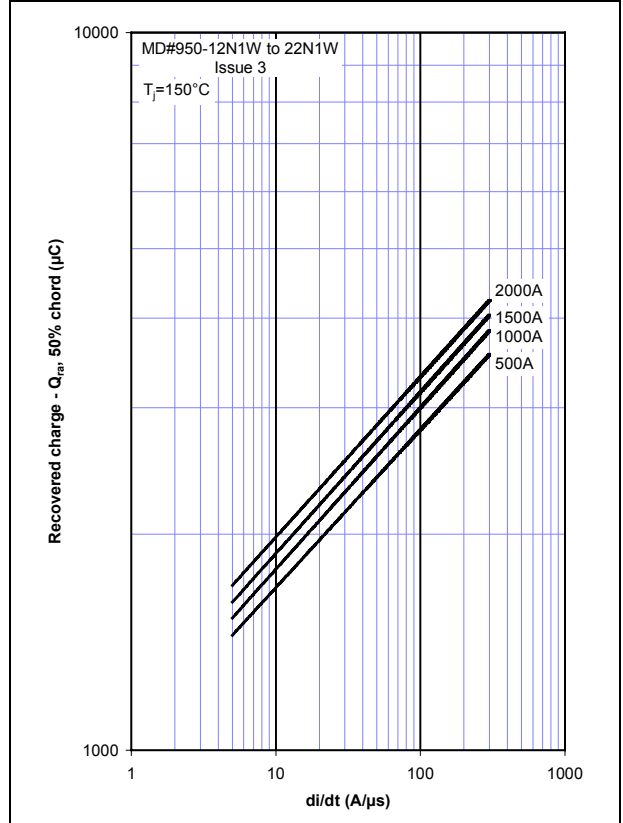

Figure 6 - Peak reverse recovery current, I_{rm}

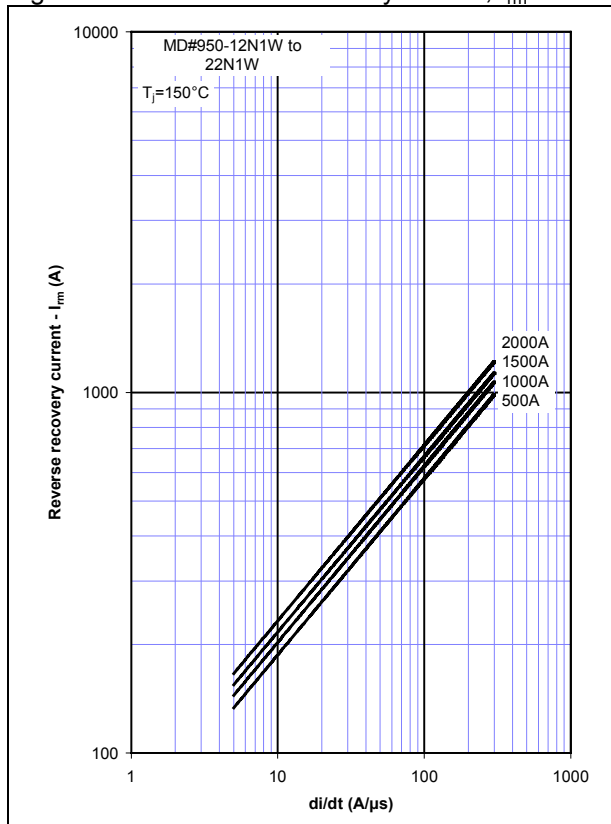

Figure 7 - Maximum recovery time, t_{rr} (50% chord)

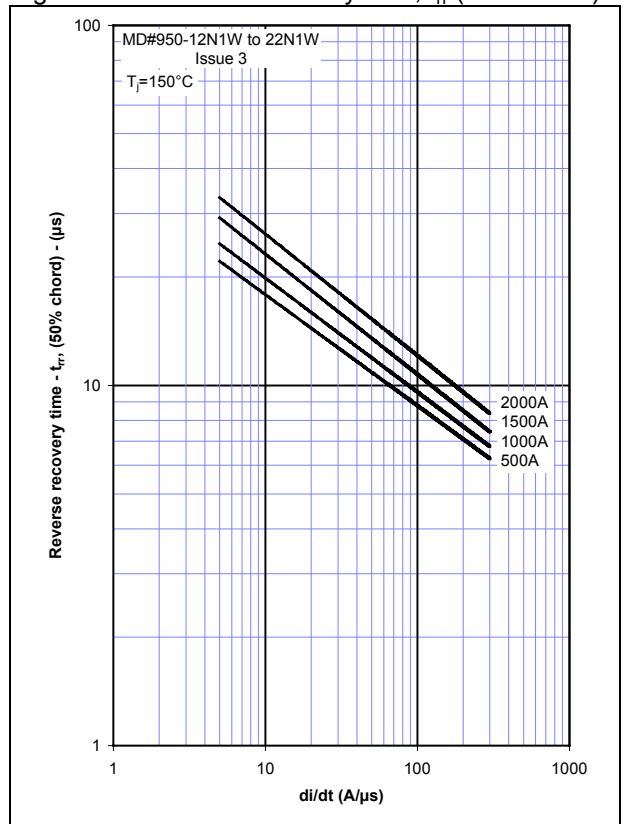

Figure 8 – Forward current vs. Power dissipation

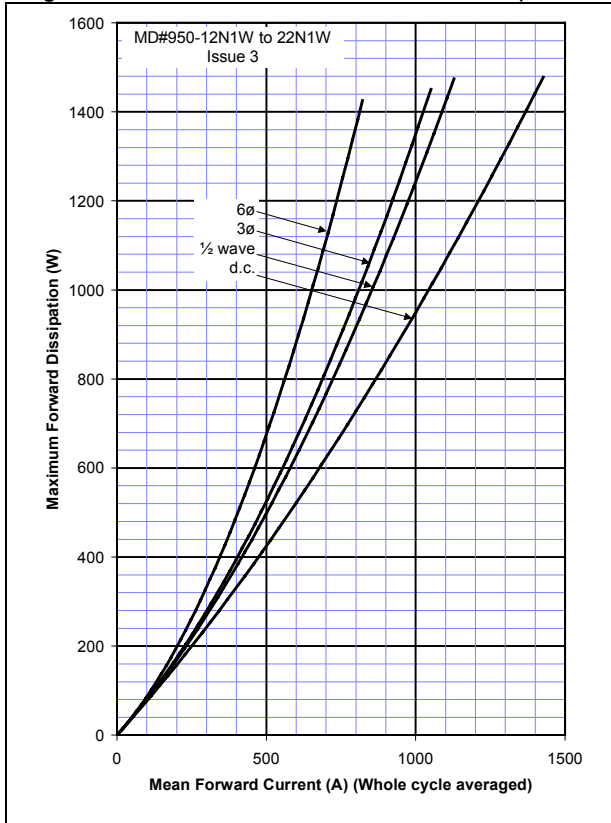

Figure 9 – Forward current vs. Water temperature

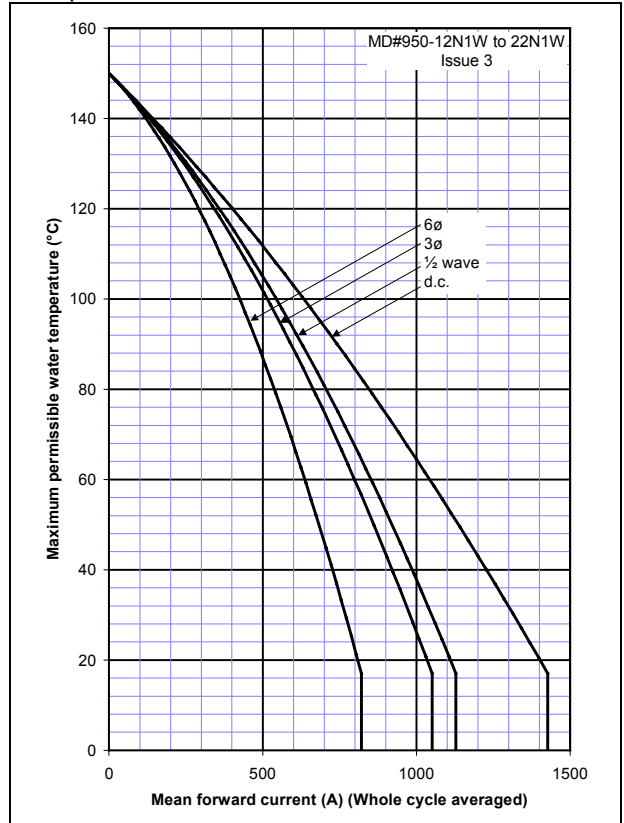
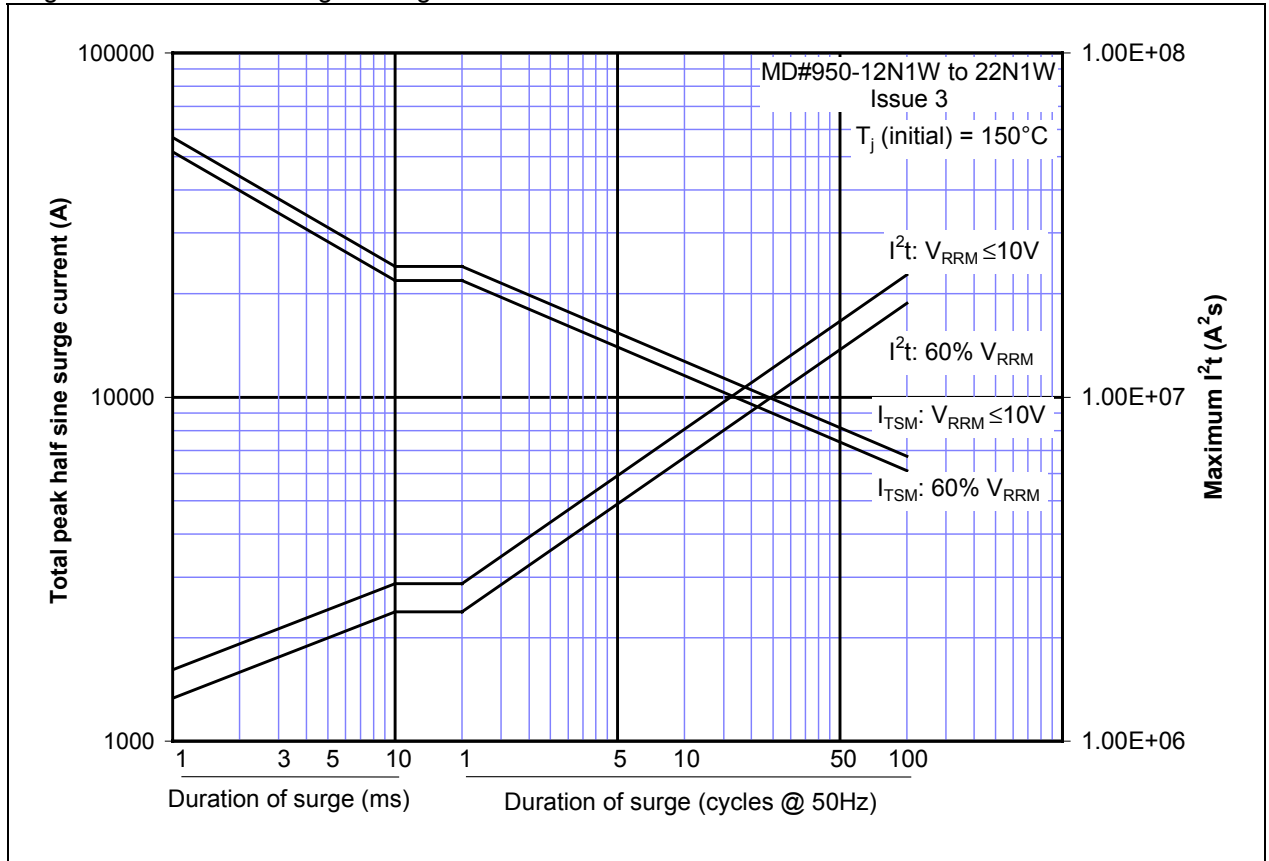
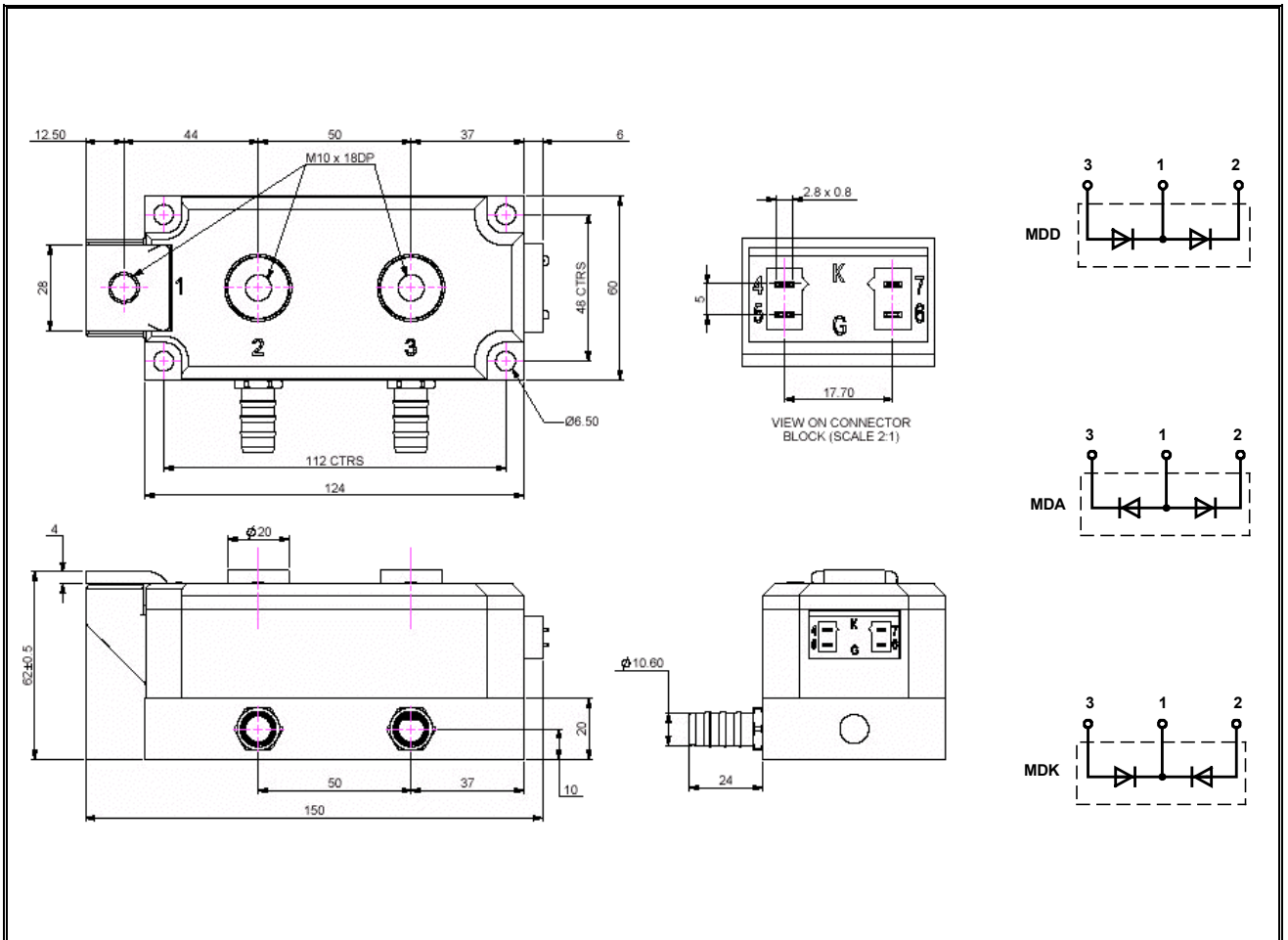

Figure 10 - Maximum surge Rating



Outline Drawing & Ordering Information



ORDERING INFORMATION

(Please quote 11 digit code as below)

| M | D# | 950 | ◆◆ | N | 1 | W |
|-----------------|-------------------------------|------------------------|-------------------------------------|----------------|--------------------|-------------------|
| Fixed Type Code | Configuration code DD, DA, DK | Average Current Rating | Voltage code $V_{DRM}/100$ 12-22 | Standard diode | Fixed Version Code | Water cooled base |

Order code: MDD950-14N1W – MDD configuration, 1400V V_{DRM} , V_{RRM} , water cooled base

IXYS Semiconductor GmbH
 Edisonstraße 15
 D-68623 Lampertheim
 Tel: +49 6206 503-0
 Fax: +49 6206 503-627
 E-mail: marcom@ixys.de



IXYS Corporation
 3540 Bassett Street
 Santa Clara CA 95054 USA
 Tel: +1 (408) 982 0700
 Fax: +1 (408) 496 0670
 E-mail: sales@ixys.net

Westcode Semiconductors Ltd
 Langley Park Way, Langley Park,
 Chippenham, Wiltshire, SN15 1GE.
 Tel: +44 (0)1249 444524
 Fax: +44 (0)1249 659448
 E-mail: WSL.sales@westcode.com



An IXYS Company

www.westcode.com

Westcode Semiconductors Inc
 3270 Cherry Avenue
 Long Beach CA 90807 USA
 Tel: +1 (562) 595 6971
 Fax: +1 (562) 595 8182
 E-mail: WSI.sales@westcode.com

The information contained herein is confidential and is protected by Copyright. The information may not be used or disclosed except with the written permission of and in the manner permitted by the proprietors IXYS Semiconductors GmbH.

© IXYS Semiconductor GmbH.

In the interest of product improvement, IXYS reserves the right to change specifications at any time without prior notice.