

Phase Control Thyristor Module Types MCO800-16io1 to MCO800-18io1

Absolute Maximum Ratings

V_{RRM} V_{DRM} [V]	Type
1600	MCO800-16io1
1800	MCO800-18io1

	VOLTAGE RATINGS	MAXIMUM LIMITS	UNITS
V_{DRM}	Repetitive peak off-state voltage ¹⁾	1600-1800	V
V_{DSM}	Non-repetitive peak off-state voltage ¹⁾	1600-1800	V
V_{RRM}	Repetitive peak reverse voltage ¹⁾	1600-1800	V
V_{RSM}	Non-repetitive peak reverse voltage ¹⁾	1700-1900	V

	OTHER RATINGS	MAXIMUM LIMITS	UNITS
$I_{T(AV)M}$	Maximum average on-state current, $T_c=55^\circ\text{C}$ ²⁾	1260	A
$I_{T(AV)M}$	Maximum average on-state current, $T_c=86^\circ\text{C}$ ²⁾	800	
$I_{T(AV)M}$	Maximum average on-state current, $T_c=85^\circ\text{C}$ ²⁾	820	
$I_{T(RMS)M}$	Nominal RMS on-state current, $T_c=25^\circ\text{C}$ ²⁾	2564	
$I_{T(d.c.)}$	D.C. on-state current, $T_c=25^\circ\text{C}$ ²⁾	2048	
I_{TSM}	Peak non-repetitive surge $t_p=10\text{ms}$, $V_{rm}=60\%V_{RRM}$ ³⁾	32.7	kA
I_{TSM2}	Peak non-repetitive surge $t_p=10\text{ms}$, $V_{rm}\leq 10\text{V}$ ³⁾	36.0	kA
I^2t	I^2t capacity for fusing $t_p=10\text{ms}$, $V_{rm}=60\%V_{RRM}$ ³⁾	5.35×10^6	A^2s
I^2t	I^2t capacity for fusing $t_p=10\text{ms}$, $V_{rm}\leq 10\text{V}$ ³⁾	6.48×10^6	A^2s
$(di/dt)_{cr}$	Critical rate of rise of on-state current ⁴⁾	(continuous, 50Hz)	75
		(repetitive, 50Hz, 60s)	150
		(non-repetitive)	300
V_{RGM}	Peak reverse gate voltage	5	V
$P_{G(AV)}$	Mean forward gate power	4	W
P_{GM}	Peak forward gate power	30	W
V_{ISOL}	Isolation Voltage ⁵⁾	3500	V
$T_{vj\ op}$	Operating temperature range	-40 to +125	$^\circ\text{C}$
T_{stg}	Storage temperature range	-40 to +150	$^\circ\text{C}$

Notes:

- 1) De-rating factor of 0.13% per $^\circ\text{C}$ is applicable for T_{vj} below 25°C .
- 2) Single phase; 50 Hz, 180° half-sinewave.
- 3) Half-sinewave, 125°C T_{vj} initial.
- 4) $V_D = 67\% V_{DRM}$, $I_{FG} = 2\text{ A}$, $t_r \leq 0.5\mu\text{s}$, $T_c = 125^\circ\text{C}$.
- 5) AC RMS voltage, 50 Hz, 1min test

Characteristics

	PARAMETER	MIN.	TYP.	MAX.	TEST CONDITIONS ¹⁾	UNITS
V _{TM}	Maximum peak on-state voltage	-	-	1.38	I _{TM} =2400A	V
		-	-	1.50	I _{TM} =3000A	V
V _{T0}	Threshold voltage	-	-	0.890		V
r _T	Slope resistance	-	-	0.154		mΩ
(dv/dt) _{cr}	Critical rate of rise of off-state voltage	1000	-	-	V _D = 80% V _{DRM} , linear ramp, Gate o/c	V/μs
I _{DRM}	Peak off-state current	-	-	2	Rated V _{DRM} , T _j =25°C	mA
		-	-	100	Rated V _{DRM}	
I _{RPM}	Peak reverse current	-	-	2	Rated V _{RPM} , T _j =25°C	mA
		-	-	100	Rated V _{RPM}	
V _{GT}	Gate trigger voltage	-	-	2.5	T _{vj} = 25°C, V _D = 10 V, I _T = 3 A	V
I _{GT}	Gate trigger current	-	-	250		mA
I _H	Holding current	-	-	450	T _{vj} = 25°C	mA
I _L	Latching current	-	-	1000	T _{vj} = 25°C	mA
t _{gd}	Gate controlled turn-on delay time	-	0.8	2.0	V _D =67% V _{DRM} , I _T =2000A, di/dt=10A/μs, I _{FG} =2A, t _r =0.5μs, T _j =25°C	μs
t _{gt}	Turn-on time	-	1.4	3.0		
Q _{rr}	Recovered Charge	-	3600	-	I _{TM} =1000A, t _p =1000μs, di/dt=10A/μs, V _r =50V	μC
Q _{ra}	Recovered Charge, 50% chord	-	2150	2400		μC
I _{rm}	Reverse recovery current	-	150	-		A
t _{rr}	Reverse recovery time, 50% chord	-	29	-		μs
t _q	Turn-off time	-	350	-	I _{TM} =1000A, t _p =1000μs, di/dt=10A/μs, V _r =50V, V _{dr} =80%V _{DRM} , dV _{dr} /dt=20V/μs	μs
		-	600	-	I _{TM} =1000A, t _p =1000μs, di/dt=10A/μs, V _r =50V, V _{dr} =80%V _{DRM} , dV _{dr} /dt=200V/μs	
R _{thJC}	Thermal resistance, junction to case	-	-	0.0405		K/W
R _{thCH}	Thermal resistance, case to heatsink	-	-	0.0100		K/W
F ₁	Mounting torque (to heatsink)	5.1	-	6.9		Nm
F ₂	Mounting torque (to terminals)	16.2	-	19.8		Nm
W _t	Weight	-	2.2	-		kg

Notes:

1) Unless otherwise indicated T_{vj}=125°C.

Notes on Ratings and Characteristics

1.0 Voltage Grade Table

Voltage Grade	V_{DRM} V_{DSM} V_{RRM} V	V_{RSM} V	V_D V_R DC V
16	1600	1700	1050
18	1800	1900	1150

2.0 Extension of Voltage Grades

This report is applicable to other voltage grades when supply has been agreed by Sales/Production.

3.0 De-rating Factor

A blocking voltage de-rating factor of 0.13%/°C is applicable to this device for T_{vj} below 25°C.

4.0 Repetitive dv/dt

Standard dv/dt is 1000V/μs.

5.0 Snubber Components

When selecting snubber components, care must be taken not to use excessively large values of snubber capacitor or excessively small values of snubber resistor. Such excessive component values may lead to device damage due to the large resultant values of snubber discharge current. If required, please consult the factory for assistance.

6.0 Rate of rise of on-state current

The maximum un-primed rate of rise of on-state current must not exceed 300A/μs at any time during turn-on on a non-repetitive basis. For repetitive performance, the on-state rate of rise of current must not exceed 150A/μs at any time during turn-on. Note that these values of rate of rise of current apply to the total device current including that from any local snubber network.

7.0 Gate Drive

The nominal requirement for a typical gate drive is illustrated below. An open circuit voltage of at least 30V is assumed. This gate drive must be applied when using the full di/dt capability of the device.

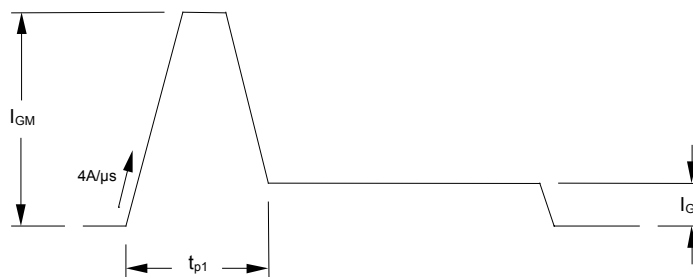

The magnitude of I_{GM} should be between five and ten times I_{GT} , which is shown on page 2. Its duration (t_{p1}) should be 20μs or sufficient to allow the anode current to reach ten times I_L , whichever is greater. Otherwise, an increase in pulse current could be needed to supply the necessary charge to trigger. The 'back-porch' current I_G should remain flowing for the same duration as the anode current and have a magnitude in the order of 1.5 times I_{GT} .

8.0 Computer Modelling Parameters

8.1 Thyristor dissipation calculations

$$I_{AV} = \frac{-V_{T0} + \sqrt{V_{T0}^2 + 4 \cdot ff^2 \cdot r_T \cdot W_{AV}}}{2 \cdot ff^2 \cdot r_T} \quad \text{and:} \quad W_{AV} = \frac{\Delta T}{R_{th}}$$

$$\Delta T = T_{j \max} - T_C$$

Where $V_{T0} = 0.89 \text{ V}$, $r_T = 0.154 \text{ m}\Omega$.

R_{th} = Supplementary thermal impedance, see table below and

ff = Form factor, see table below.

Supplementary Thermal Impedance (Junction to Case)							
Conduction Angle	30°	60°	90°	120°	180°	270°	d.c.
Square wave	0.0456	0.0449	0.0440	0.0433	0.0423	0.0411	0.0405
Sine wave	0.0448	0.0439	0.0431	0.0421	0.0409		

Form Factors							
Conduction Angle	30°	60°	90°	120°	180°	270°	d.c.
Square wave	3.464	2.449	2	1.732	1.414	1.149	1
Sine wave	3.98	2.778	2.22	1.879	1.57		

8.2 Calculating thyristor V_T using ABCD coefficients – For loss calculations

The on-state characteristic, I_T vs. V_T , is represented in two ways;

- the well established V_{T0} and r_T tangent used for rating purposes and
- a set of constants A, B, C, D, forming the coefficients of the representative equation for V_T in terms of I_T given below:

$$V_T = A + B \cdot \ln(I_T) + C \cdot I_T + D \cdot \sqrt{I_T}$$

The constants, derived by curve fitting software, are given below for both hot and cold characteristics. The resulting values for V_T agree with the true device characteristic over a current range, which is limited to that plotted.

25°C Coefficients		125°C Coefficients	
A	1.0361917	A	0.3800106
B	-9.15653×10^{-4}	B	0.1133246
C	1.012637×10^{-4}	C	2.011823×10^{-4}
D	1.072219×10^{-3}	D	-9.874997×10^{-3}

8.3 D.C. Thermal Impedance Calculation

$$r_t = \sum_{p=1}^{p=n} r_p \cdot \left(1 - e^{-\frac{t}{\tau_p}} \right)$$

Where $p = 1$ to n

- n = number of terms in the series and
- t = Duration of heating pulse in seconds.
- r_t = Thermal resistance at time t .
- r_p = Amplitude of p_{th} term.
- τ_p = Time Constant of r_{th} term.

The coefficients for this device are shown in the tables below:

D.C. Junction to Case						
Term	1	2	3	4	5	6
r_p	1.0×10^{-5}	0.016708	0.018317	4.346771×10^{-3}	1.004820×10^{-3}	1.0×10^{-5}
τ_p	2.460066	0.999836	21.998376	9.793053×10^{-3}	2.003674	5.007343

9.0 Reverse recovery ratings

(i) Q_{rr} is based on 50% I_{RM} chord as shown in Fig. 1

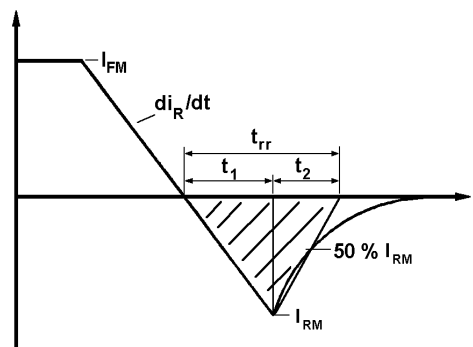

Fig. 1

(ii) Q_{rr} is based on a 150 μs integration time i.e.

$$Q_{rr} = \int_0^{150 \mu s} i_{rr} \cdot dt$$

(iii)

$$K \text{ Factor} = \frac{t_1}{t_2}$$

Curves

Figure 1 – On-state characteristics of Limit device

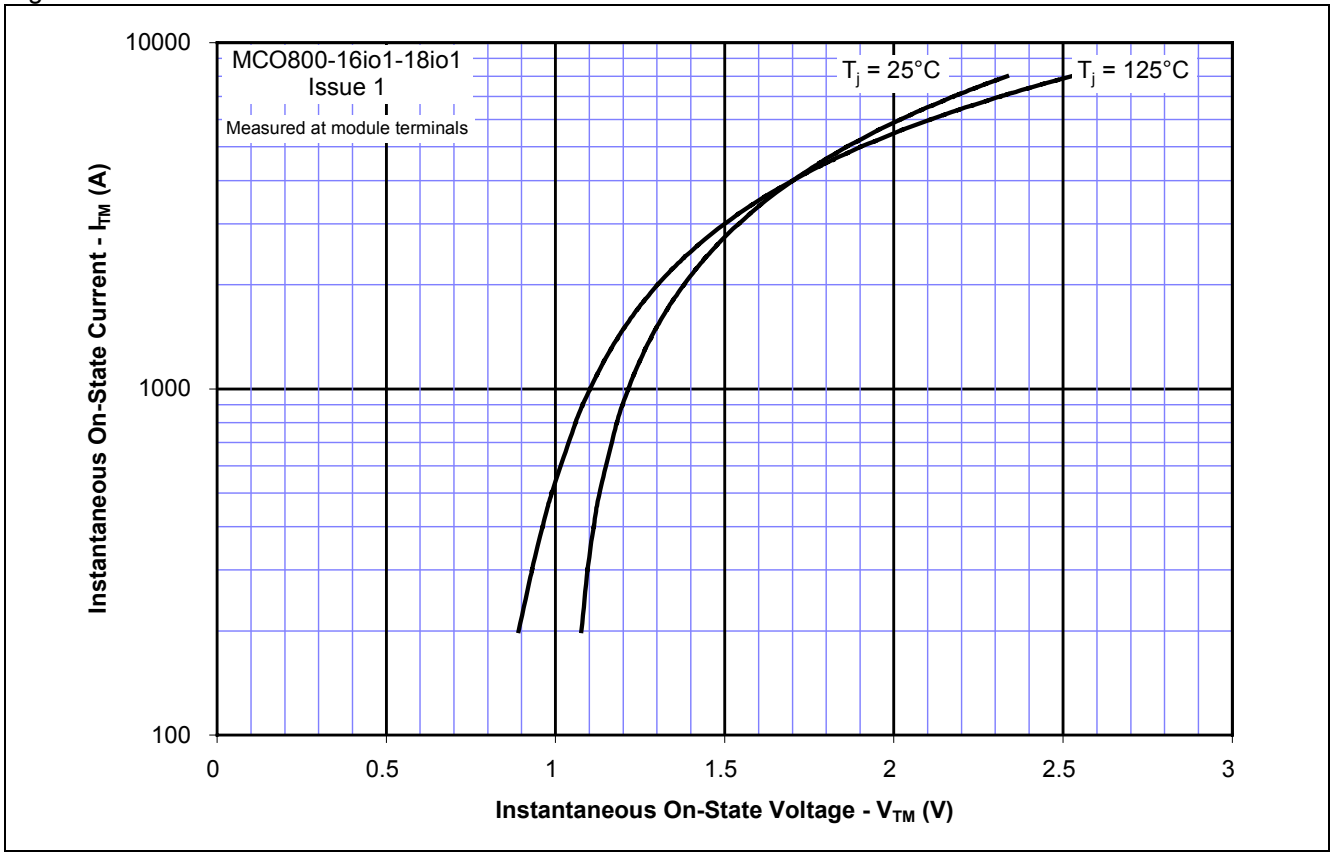

Figure 2 – Gate characteristics – Trigger limits

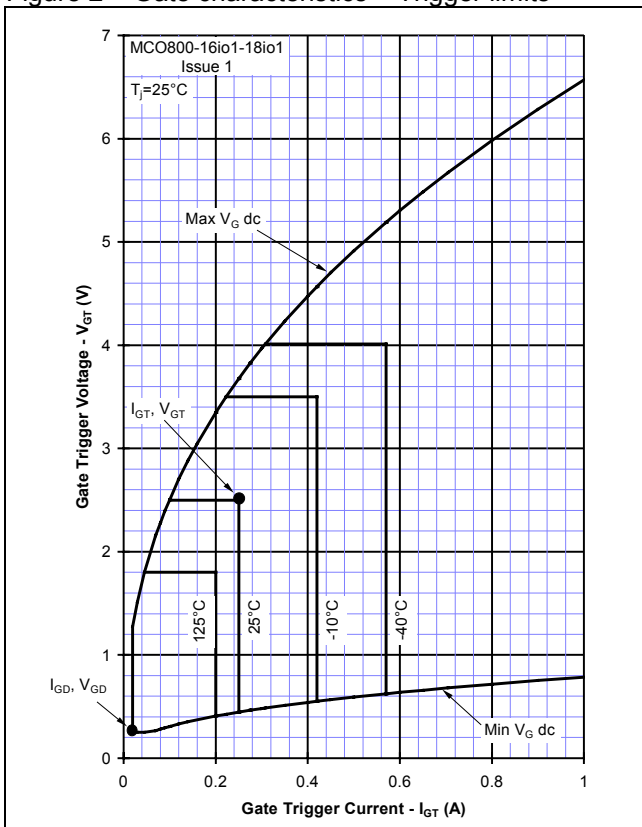

Figure 3 – Gate characteristics – Power curves

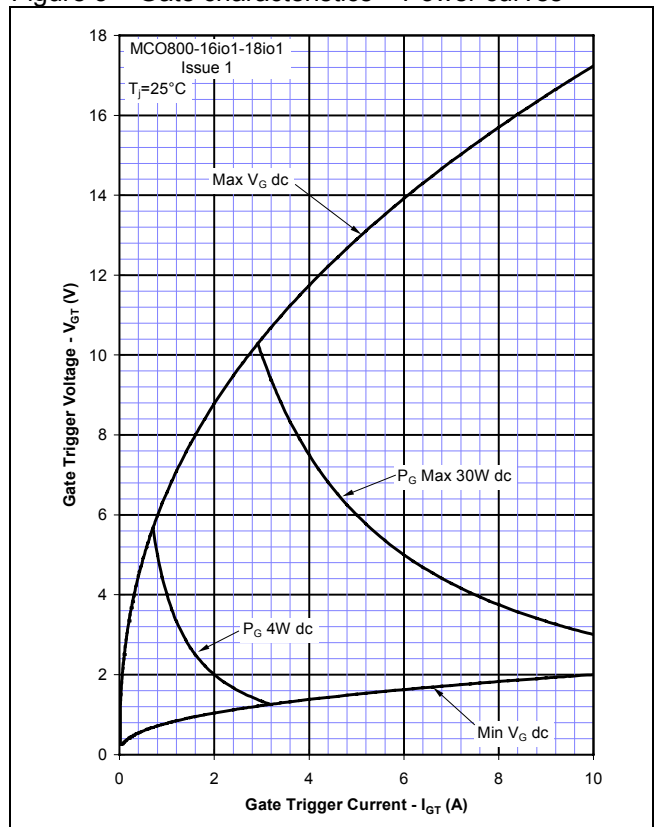

Figure 4 – Total recovered charge, Q_{rr}

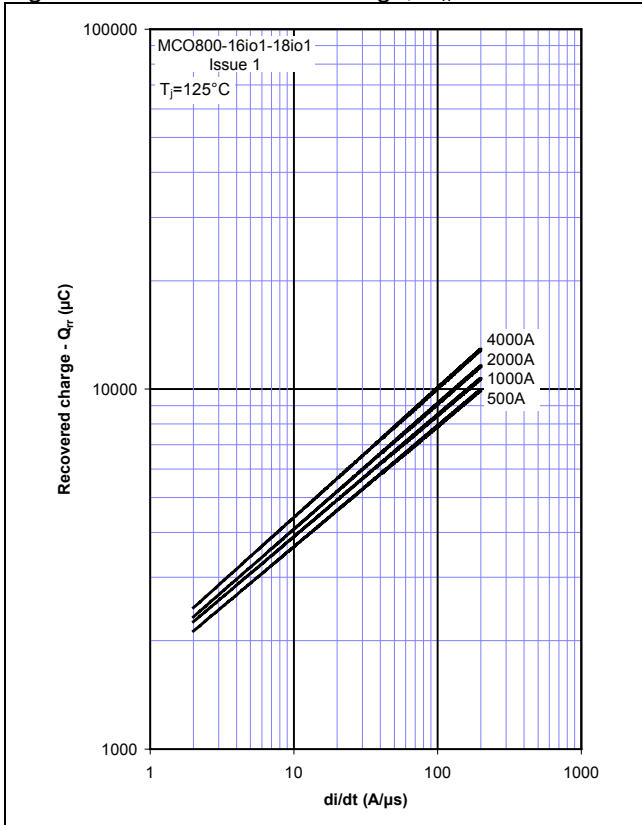

Figure 5 – Recovered charge, Q_{ra} (50% chord)

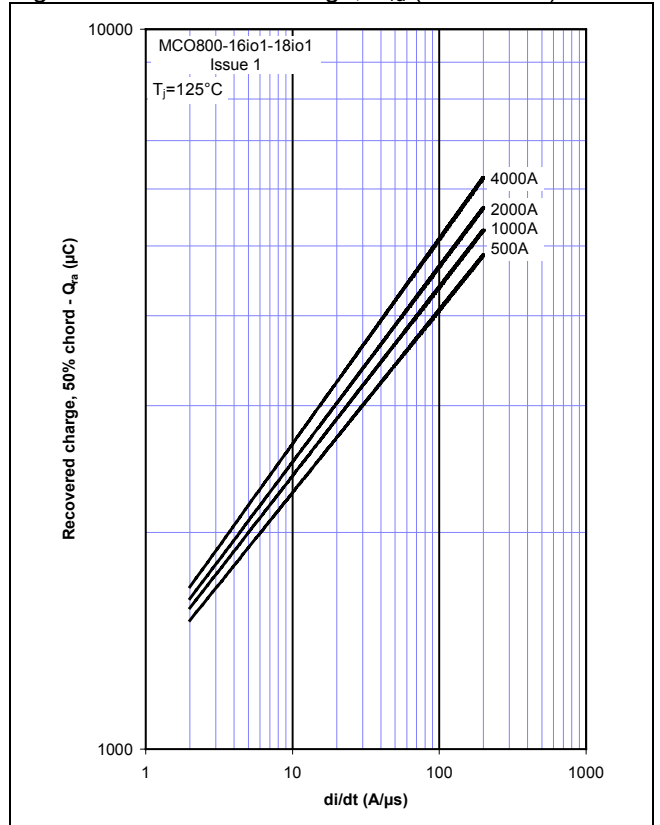

Figure 6 – Peak reverse recovery current, I_{rm}

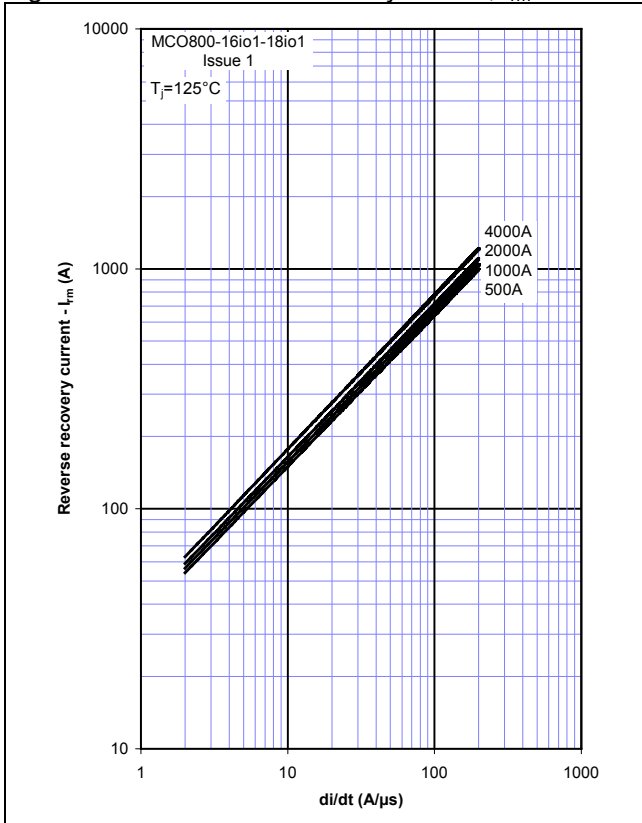

Figure 7 – Maximum recovery time, t_{rr} (50% chord)

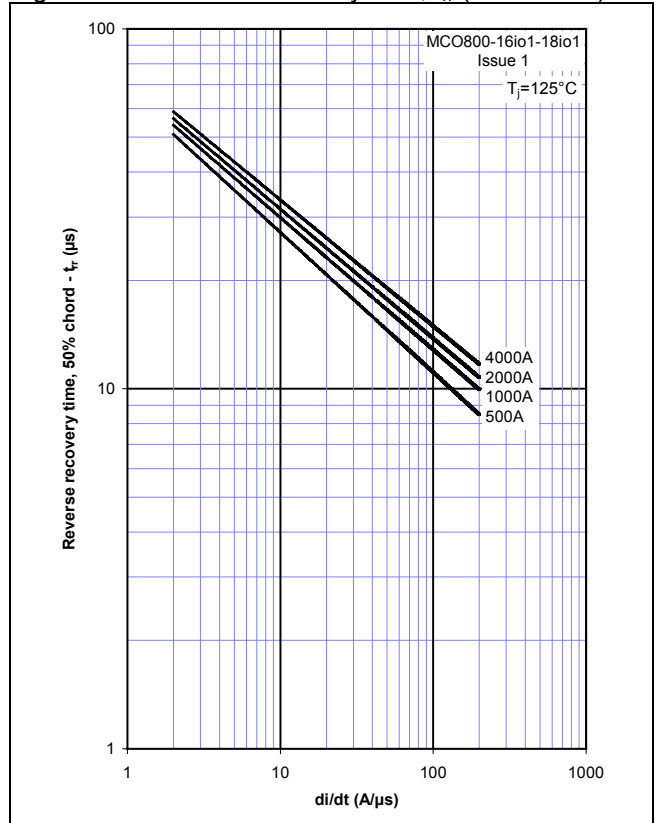

Figure 8 – On-state current vs. Power dissipation – Sine wave

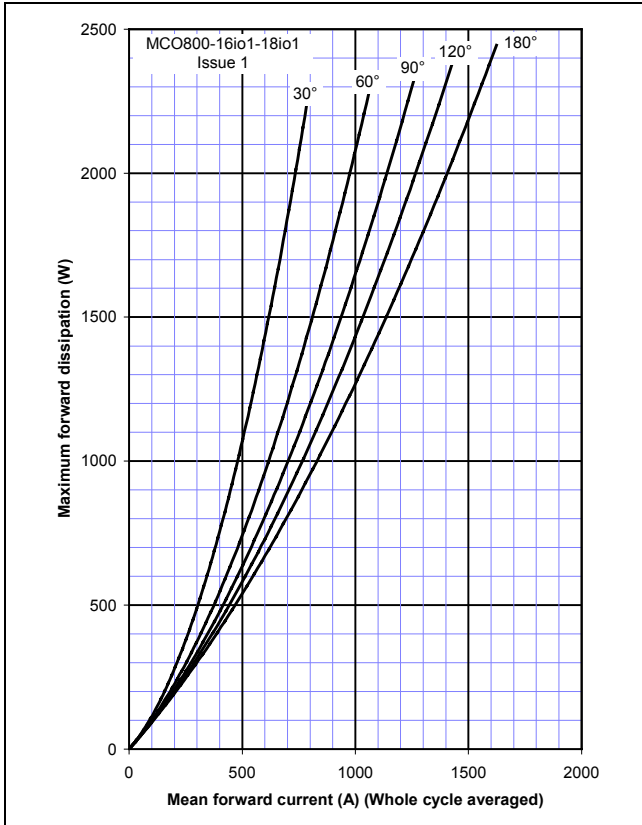

Figure 9 – On-state current vs. Heatsink temperature – Sine wave

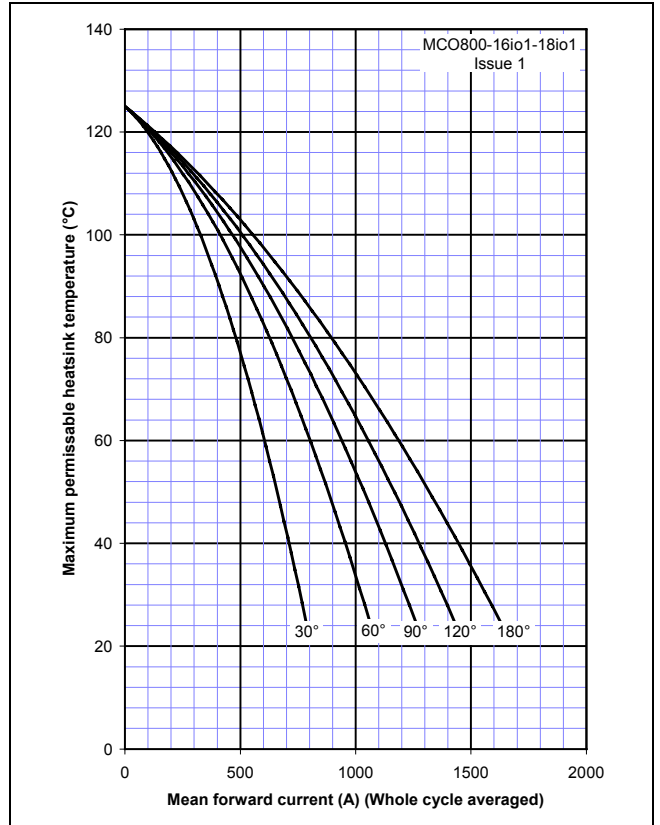

Figure 10 – On-state current vs. Power dissipation – Square wave

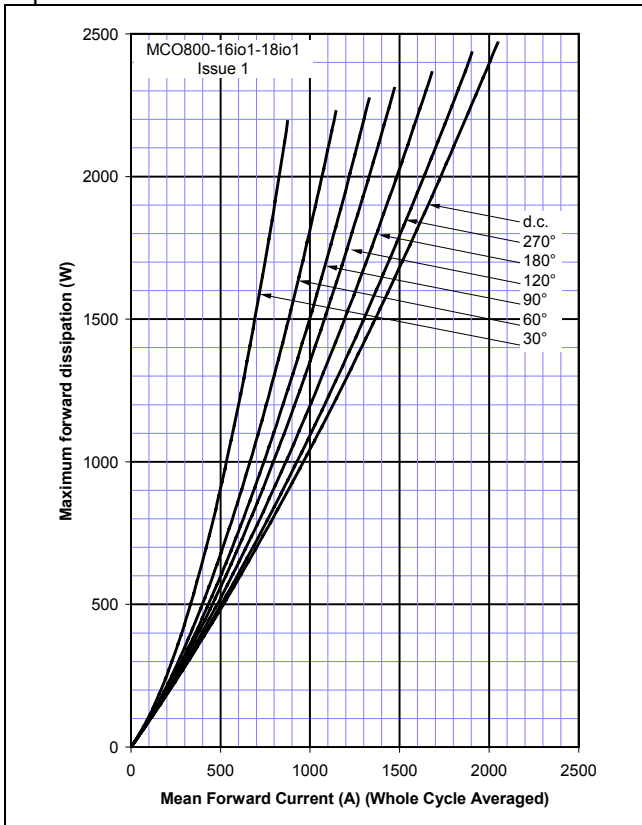

Figure 11 – On-state current vs. Heatsink temperature – Square wave

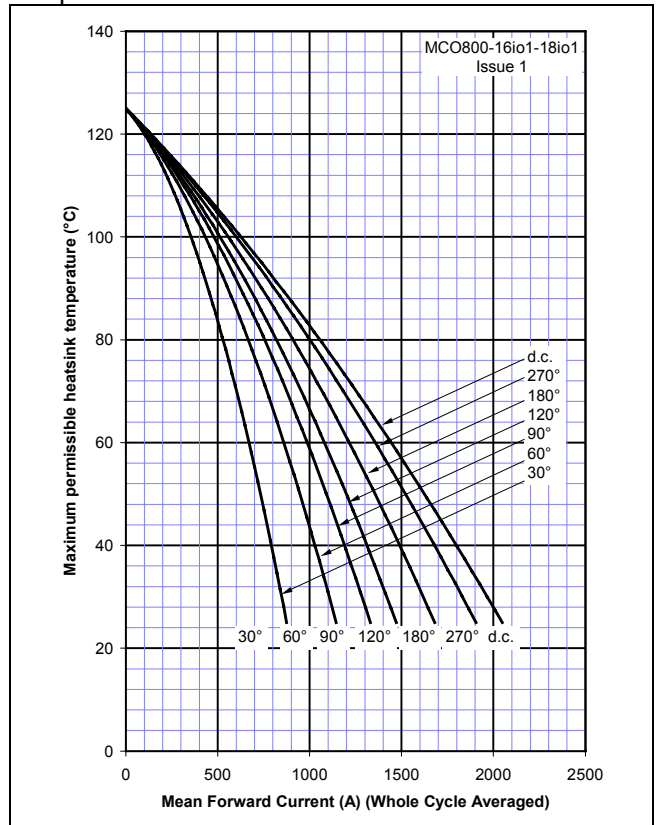

Figure 12 – Maximum surge and I^2t Ratings

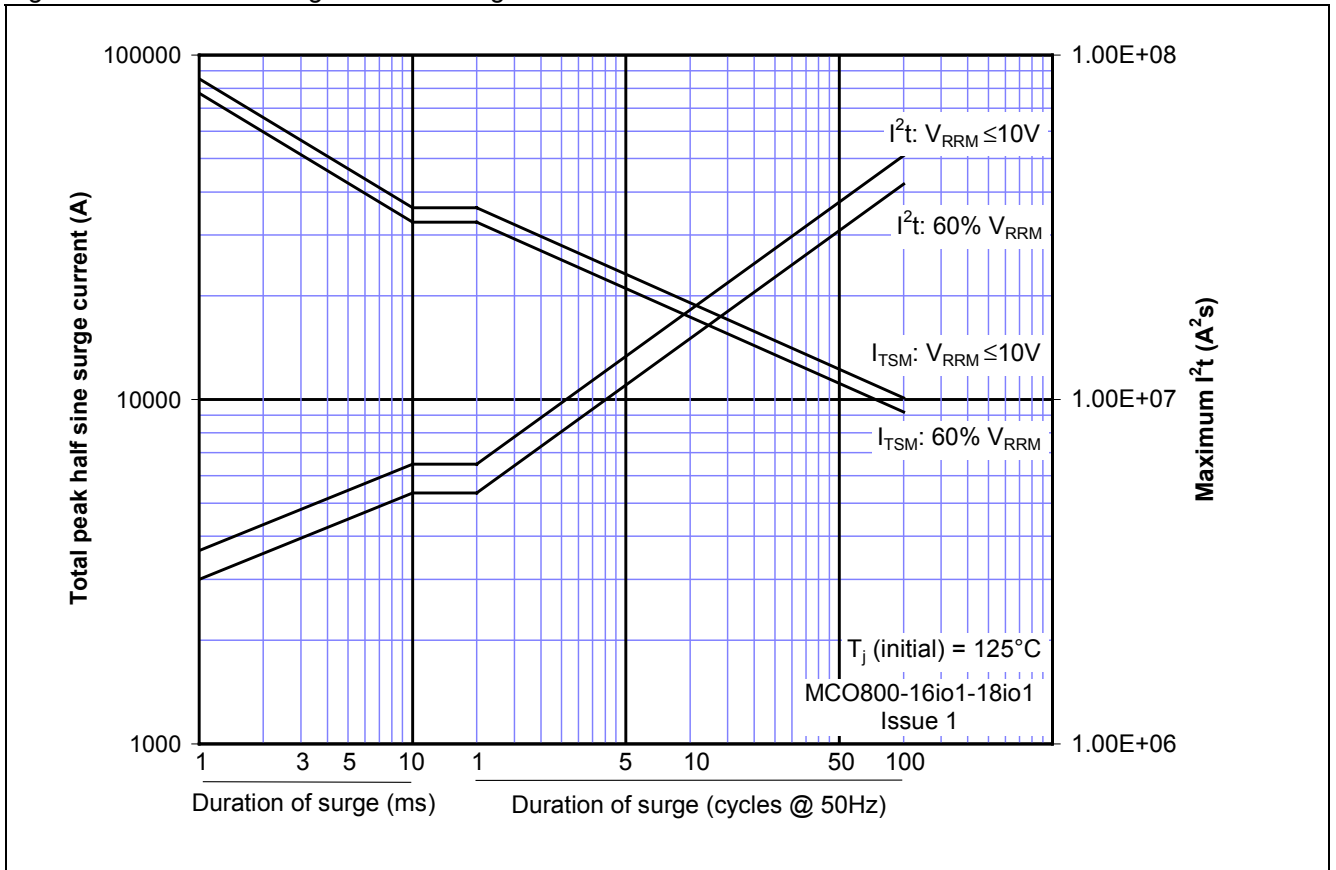
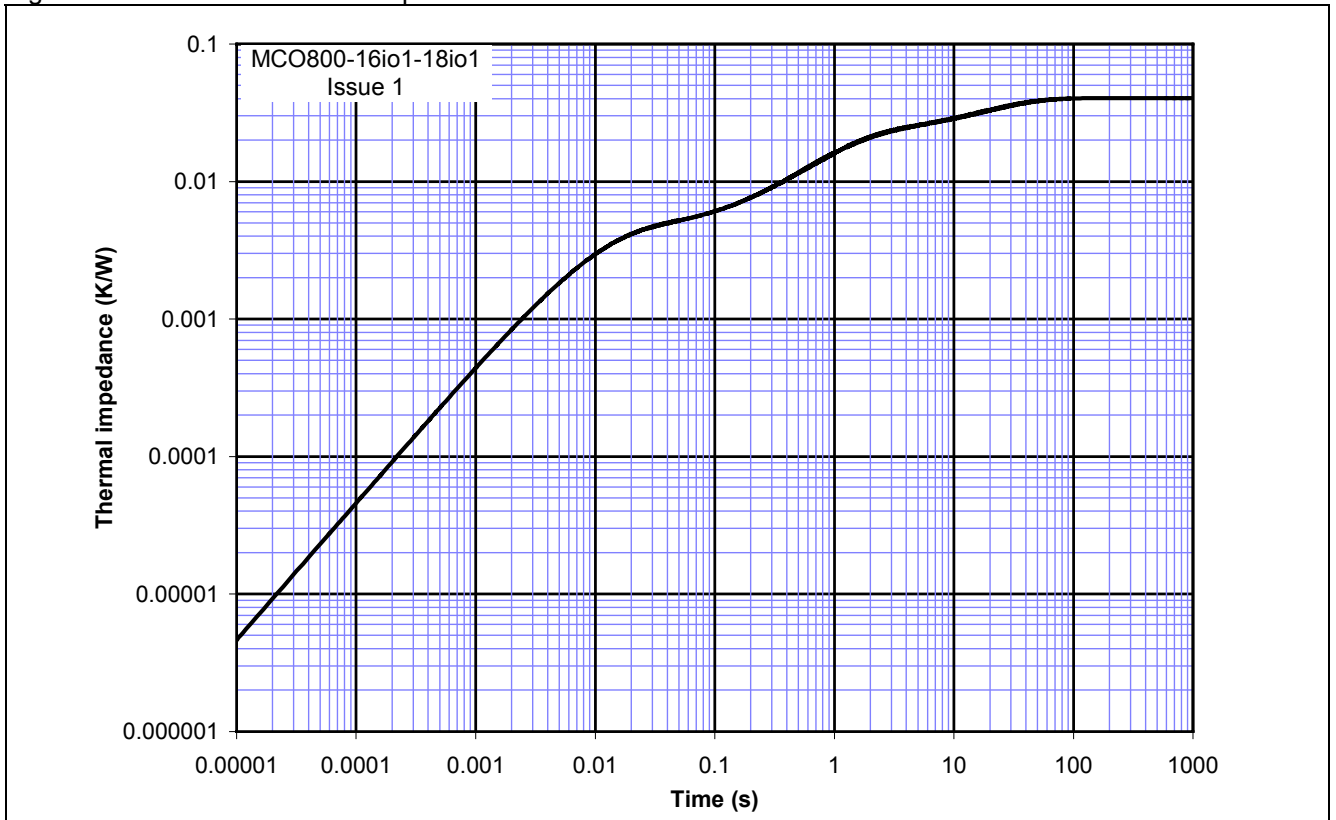
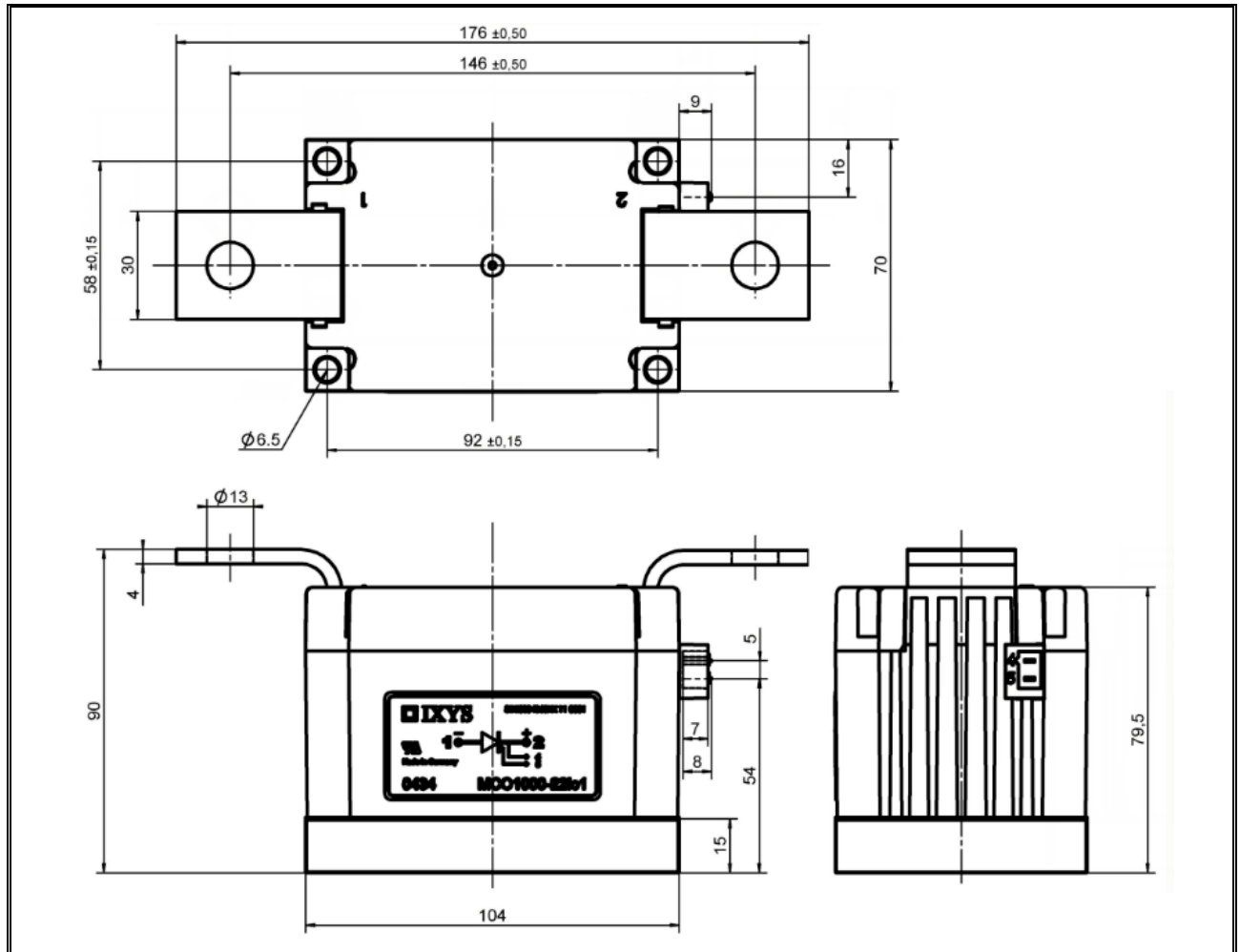

Figure 13 – Transient Thermal Impedance



Outline Drawing & Ordering Information



ORDERING INFORMATION

(Please quote 11 digit code as below)

M	CO	800	◆◆	io	1
Fixed Type Code	Fixed Configuration code	Nominal Current Rating	Voltage code $V_{RRM}/100$ 16-18	i = Critical dv/dt 1000 V/μs o = Typical turn-off time	Fixed Version Code

Typical order code: MCO800-16io1, 1600V V_{DRM} , V_{RRM} thyristor module

IXYS Semiconductor GmbH
 Edisonstraße 15
 D-68623 Lampertheim
 Tel: +49 6206 503-0
 Fax: +49 6206 503-627
 E-mail: marcom@ixys.de



www.ixys.com

IXYS Corporation
 3540 Bassett Street
 Santa Clara CA 95054 USA
 Tel: +1 (408) 982 0700
 Fax: +1 (408) 496 0670
 E-mail: sales@ixys.net



An IXYS Company

www.westcode.com

Westcode Semiconductors Ltd
 Langley Park Way, Langley Park,
 Chippenham, Wiltshire, SN15 1GE.
 Tel: +44 (0)1249 444524
 Fax: +44 (0)1249 659448
 E-mail: WSL.sales@westcode.com

Westcode Semiconductors Inc
 3270 Cherry Avenue
 Long Beach CA 90807 USA
 Tel: +1 (562) 595 6971
 Fax: +1 (562) 595 8182
 E-mail: WSI.sales@westcode.com

The information contained herein is confidential and is protected by Copyright. The information may not be used or disclosed except with the written permission of and in the manner permitted by the proprietors IXYS Semiconductors GmbH.

© IXYS Semiconductor GmbH.

In the interest of product improvement, IXYS reserves the right to change specifications at any time without prior notice.

Devices with a suffix code (2-letter, 3-letter or letter/digit/letter combination) added to their generic code are not necessarily subject to the conditions and limits contained in this report.